

Installation instructions for pneumatic plants

1. Compressed-air supply

- 1.1 Required quantity of compressed air
- 1.2 Required compressor output
- 1.3 Volume of the compressed-air reservoir
- 1.4 Quality of air with regard to oil and dust contents

2. Compressed-air treatment (with regard to condensation)

- 2.1 Without treatment
- 2.2 With pressure reduction in steps
- 2.3 With cooling dryer
- 2.4 With adsorption dryer

3. Compressed-air distribution

- 3.1 High-pressure lines
- 3.2 Supply and signal-pressure lines
- 3.3 Equipment connection

4. Supply-air distributor installation

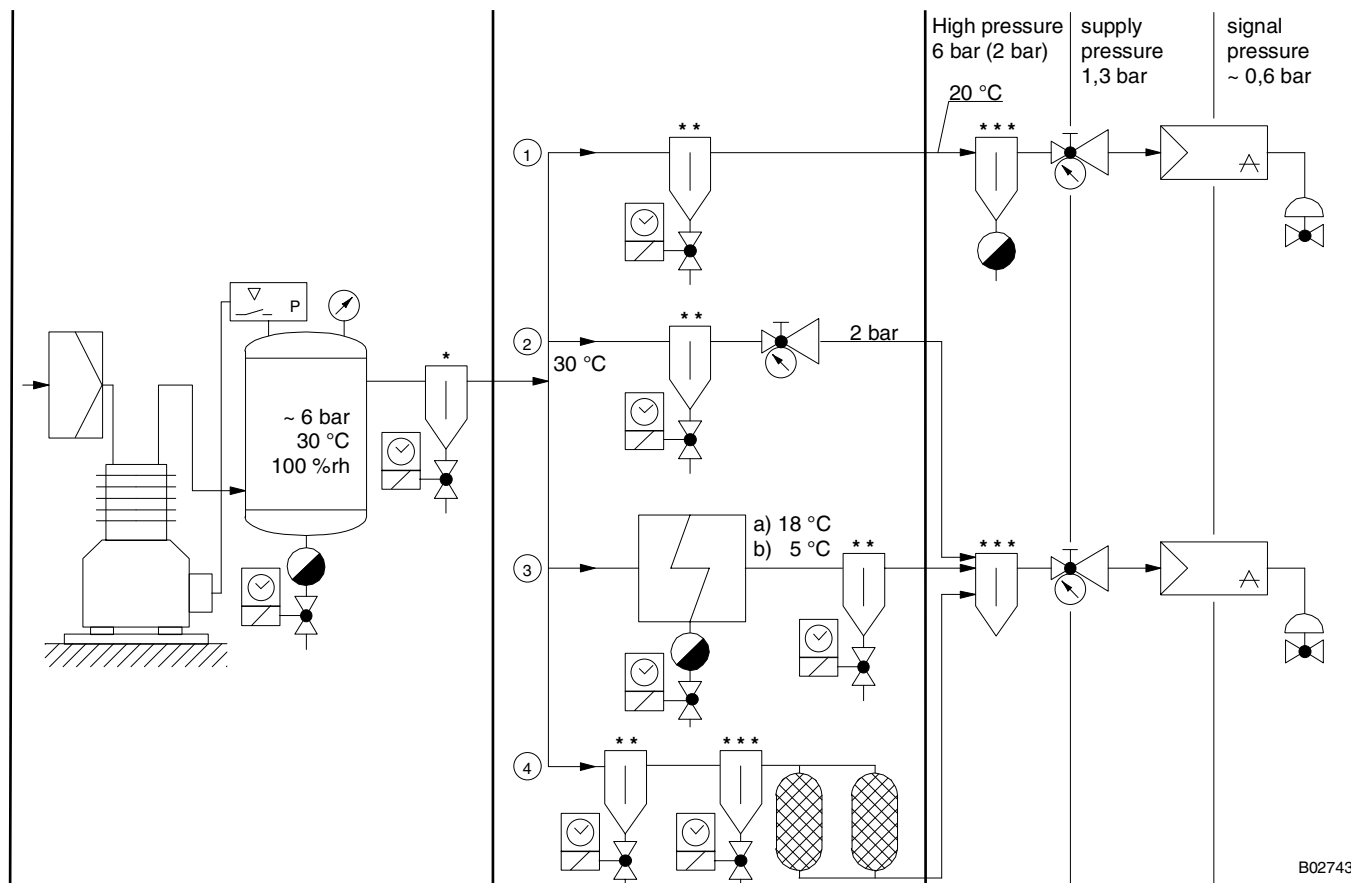

B02743

Examples for compressed-air treatment	Lower limit temp. (saturation limit)		
	High pressure network	Supply network	Signal network
Example ① Without treatment cooling from 30 °C to 20 °C in the network piping, condensate: 2,2 g/m ³ _n		3 °C	-2 °C
Example ② Pressure reduction in steps high pressure only 2 bar, no condensate	15 °C	12 °C	6 °C
Example ③ Cooling dryer a) Water cooler, 18 °C, condensate 2,5 g/m ³ _n b) Refrigerating unit, 5 °C, condensate 3,8 g/m ³ _n	18 °C 5 °C	1 °C -10 °C	-4 °C < -10 °C
Example ④ Adsorption dryer, e.g. drying to 0,3 g/m ³ _n	-10 °C	-20 °C	< -20 °C

* Pre-filter for extremely contaminated compressed air

** Fine filter for oily compressed air

*** Sub-micron filter

1. Compressed-air supply

1.1 Required quantity of compressed air

In order to determine the quantity of compressed air required, the average air consumption of all equipment connected is added up:

- For open/closed-loop control devices, the average air consumption is stated in the catalogue sheets in l_n/h
- For pneumatic drives, the air consumption per stroke is stated. This value is then multiplied by the estimated number of strokes per hour.

Example:

12 measuring transd.	33	l_n/h each	396 l_n/h
12 RCP 20	40	l_n/h each	480 l_n/h
2 XSP 31	30	l_n/h each	60 l_n/h
2 AV 44 P 20	4,3	l_n each (per stroke)	86 l_n/h (10 strokes/h)
5 AV 42 P 10	0,5	l_n each (per stroke)	25 l_n/h (10 strokes/h)
Total:			1047 l_n/h

Required quantity of air = total average
air consumption = 1,047 m^3_n/h .

1.2 Required compressor output

When calculating the capacity of the compressor, it must be taken into account that the compressor should work at a duty cycle of 50 %. The required compressor output is therefore twice the quantity of compressed air as calculated in 1.1.

Since the capacity of commercially available compressors generally does not correspond exactly to the calculated output, the model with the next higher capacity should be chosen. This provides an additional safety factor which results in prolonged service life and is further useful with regard to design tolerances, possible leaks and later additions to the installation.

Example:

Required quantity of air	1,05 m^3_n/h
Required compressor output	2,10 m^3_n/h

Please note that the compressor output is often stated for load-free operation, i.e. without back pressure. The required compressor output is, however, stated with reference to the recommended system pressure of approx. 6 bar.

1.3 Volume of the compressed-air reservoir

The air reservoir with the volume V is used as a pressure tank and together with the actual air consumption \dot{V} and the switching differential Δp of the pressure controller determines the switched-off time Δt of the compressor.

$$\Delta t = \Delta p \cdot \frac{V}{\dot{V}} \cdot 60 \text{ (min)}$$

In order to avoid frequent on/off-switching, the reservoir volume should at least be 2 % of the average air consumption per hour. $V/\dot{V} = \text{approx. } 0.02$.

A switching difference of 2 bar of the pressure controller thus results in a switched-off time of approx. 2½ min.

Example:

Total average air consumption	1047 l_n/h
Reservoir volume (2 %)	21 l
Switched-off time, approx.	2,5 min
Commercially available reservoir tank	40 l
Switched-off time, approx.	5 min

1.4 Quality of air with regard to oil and dust contents

Generally, oil- and dust-free instrument air is required for all equipment in open-loop/closed-loop control engineering. Damage caused by impure air usually only becomes evident over longer periods of time. Particularly dangerous is a mixture of oil and dust.

- Oil-free (dry-running) compressors are best suited for producing oil-free compressed air.
- Dust damages the compressor and the connected equipment. Therefore, a 20...50 μm suction filter should be fitted before and a 5 μm pre-filter should be fitted behind the compressor.
- A fine filter and a sub-micron filter should be fitted to remove oil aerosols (oil in droplets) when connecting the equipment to existing plant air networks which are usually fed by oil-lubricated compressors.
- A cooling dryer or an adsorption dryer are recommended in order to separate gaseous oil contaminations from the air.
- When an adsorption dryer is used, one fine filter and one sub-micron filter must be fitted before and one sub-micron filter should be fitted behind the compressor.
- When a cooling dryer is used, only a single sub-micron filter is required behind the compressor.
- Gaseous oil contamination must be removed by means of an activated carbon filter if, as an exception, neither cooling dryers nor adsorption dryers can be installed. This filter must be located between the fine filter and the sub-micron filter.
- Filters installed at the compressor and in the reduction units must particularly be monitored in systems installed in a dusty environment (for example in new buildings with cement dust).
- Additional small filters are located in the connections of Sauter pneumatic equipment which eliminate residue originating from the network piping. Despite these precautions, the lines should be blown through before connecting the equipment.
- Our pressure reduction unit XFRP 5 and the corresponding accessories meet the above requirements.

2. Compressed-air treatment with regard to condensation

The pipe layout must take into account that no uncontrolled water deposits form due to condensation and that the piping cannot freeze. The corresponding air treatment depends on the minimum temperature in the individual sections of the piping (refer to the example on page 1)

- In example ①, condensate will always collect in the high-pressure section. Consequently, the pipes must be laid with a slight slope. Condensated water must be drained periodically from the lowest point. The minimum temperatures for the supply and signal networks are limited.
 - In example ② to ④, the compressed-air treatment removes the water to such a degree that no condensate collects at any point of the network piping.
- The minimum temperature for the individual pressure stages are limited. Only example ④ is permissible when high-pressure lines reach temperatures below 0 °C because otherwise the lines would freeze.

A diagram showing the maximum water content „a” of a standard cubic meter of air as a function of the temperature is used for establishing the permissible minimum temperature.

The following formula can be applied:

$$a \cong 0,8 \frac{p(T)}{p_{\text{abs}}} \text{g/m}^3_{\text{n}}$$

$p(T)$ = steam pressure in mbar at the given temperature T
 P_{abs} = absolute pressure in bar

In the following sections, the limit values mentioned on page 1 are defined numerically. The examples assume typical conditions and can be applied analogously to other conditions.

With the exception of example ②, water is always separated in the first step. The quantity depends on the degree of cooling possible in the high-pressure section. The water content remains constant after this point. Relative humidity in each case is given by the ratio of actual water content to maximum water content. The lower limit temperature is reached for any given pressure stage when the actual and the maximum water content are the same (100 %rh.).

2.1 Without compressed-air treatment, example ①

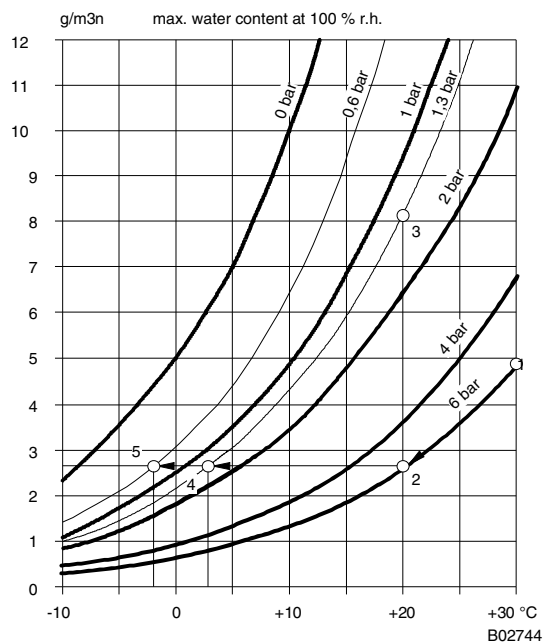

The high-pressure network is intentionally used for water separation

Point 1 Condition in the pressure tank:
 bar, 30 °C, 100 %rh.,
 water content **4,8 g/m³_n**

Point 2 Condition in the high-pressure network
 cooling to 20 °C, 6 bar, 100 %rh.,
 water content **2,6 g/m³_n**

Amount of condensate: 4,8 – 2,6 = **2,2 g/m³_n**

Point 3 After the pressure drop to 1,3 bar, a water content of 8,1 g/m³_n would be possible. The actual water content is, however, only 2,6 g/m³_n, i.e.
 rh. = 2,6/8,1 = 0,32 = **32 %**

Point 4 Lower limit temperature in the supply network
 (1,3 bar) = 3 °C
 (max. water content = actual water content)

Point 5 Lower limit temperature in the signal network
 (approx. 0,6 bar) = -2 °C

2.4 With adsorption dryer, example ④

In the adsorption dryer, the air is led through a container with hygroscopic material. Dependent on size and flow rate, the water content can easily be reduced to less than $0,3 \text{ g/m}^3_n$ (observe manufacturer's information). This results in a lower temperature limit of $-10 \text{ }^\circ\text{C}$ for the high-pressure network (approx. $-20 \text{ }^\circ\text{C}$ for the supply network).

The adsorption dryer must be periodically regenerated; for this reason, switchable double systems are often used. The service life of a filling is considerably extended if a cooling dryer is connected in front of the adsorption dryer.

- Only oil-free compressors must be used in connection with adsorption dryers.

3. Compressed-air distribution

3.1 High-pressure line, approx. 6 bar

The high-pressure lines leading to the reduction unit is usually laid with copper or plastic pipes. In example ① (without compressed-air treatment), the pipes must be laid at a slope and drained periodically at the lowest points.

With treated air, the operating temperature must not fall below the lower limit temperature as specified in Section 2; otherwise water may condensate.

3.2 Supply and signal-pressure lines

- Polyethylene, polyamide or soft copper pipes will mostly be used for piping installed with screwed connections. In most cases, the softer and less expensive polyethylene tube is used if no special requirements are to be observed (fire hazard, damage caused by rodents etc.).

Copper pipes are to be laid in such a manner that no high forces are acting on the connected equipment (particularly in case of plastic housings). For this purpose, the last 30 cm before the equipment connection are often laid with plastic tubes.

- A flexible tube made of special polyurethane has been developed for lines which are only pushed onto a nipple (see chapter 69).

In order to prevent condensation, the lower limit temperatures according to Section 2 must be observed. The normal pipe section dimensions are 6×1 (external diameter 6 mm, wall thickness 1 mm). For long lines and high air throughput, the additional pressure drop in the supply line must be taken into consideration (see Section 4).

3.3 Equipment connection

- Sauter equipment usually is provided with an internal thread Rp $\frac{1}{8}$ (ISO 7/1). They therefore fit together with the commonly used conical screw-in nipples R $\frac{1}{8}$ (ISO 7/1) (see chapter 69). PTFE tape or a special sealing stick (accessory no. 297169) are recommended as sealing materials (do not use Loctite on plastics). Limited torque must be applied when metal nipples are screwed into plastic housings (use plastic nipples if possible).
- For fitting purposes (recessed mounting) and because of the type of construction, some devices are equipped with fixed or screw-in plug nipples (see chapter 69). Use only polyurethane tubing for plug nipples. An additional clamp (accessory no. 277790) can be used as a tube grip or for temperatures over $40 \text{ }^\circ\text{C}$.
- Push tube off from the nipple instead of pulling. Use the tube remover (service set 297508).
- Cut off excessively widened tube ends.

4. Guidelines for supply-air distributor installations

Generally, a supply pressure of 1,3 bar ± 0,1 bar is specified for our pneumatic equipment. This pressure must be maintained at the distributor manifold, even when the connected devices demand max. air supply. Otherwise malfunctions may occur in all of the devices connected to this particular manifold. This section explains the system interactions and provides guidelines for planning and implementing supply networks.

The behaviour of a supply network is determined by the following characteristics:

- 1) Internal resistance of the pressure source
- 2) Typical max. air throughput \dot{V}_{max}
- 3) Influence of supply pressure on equipment

4.1 Internal resistance of the pressure source

The pressure in a compressed air network will always be reduced slightly when a certain amount of air is discharged from the system. The pressure drop at the point of discharge is the sum of several flow-dependent pressure drops caused by:

- Pressure reducing units
- Line resistance
- Control valves
- or any other flow resistance

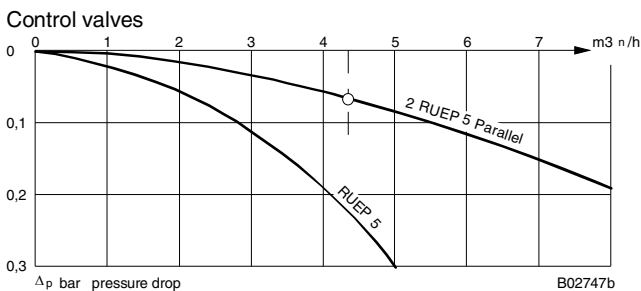
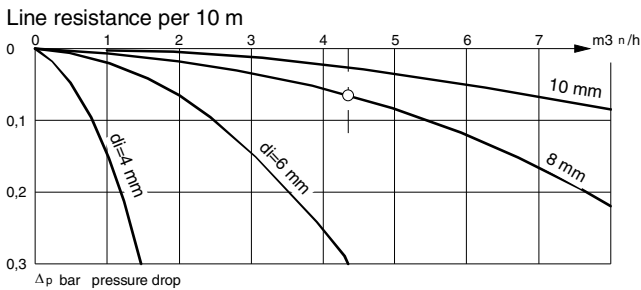
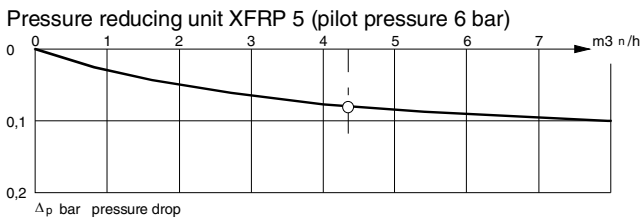

In order to estimate the total pressure drop, the air throughput rate \dot{V}_{max} is determined according to 4.2) and the relevant Δp -values of the corresponding load curves are added up:

The Δp -values of the piping are specified for a length of 10 m and must be converted in proportion to the actual length of the lines. The points marked in the drawing refer to the example on page 7 with $\dot{V}_{max} = 4,3 \text{ m}^3/\text{h}$

4.2 Typical max. air throughput „ \dot{V}_{max} “

The typical maximum air throughput rate takes into account not only the average air consumption (for establishing the proper compressor capacity) but also an amount of operating air required for transient compensation of disturbances or setpoint re-adjustments. This air throughput is not related to the „required“ amount of air as used for establishing the compressor.

For temperature and humidity control loops, the following empirical formulae apply:

With 2...10 control loops with amplifier or positioner, the following is added up: $\dot{V}_{max} =$

- + average air consumption for all connected devices
- + an additional demand of 0.1 m³/h per valve or drive (AV 44/45 P, 0,2 m³/h each)
- + max. air supply for 2 devices at maximum output

For more than 10 control loops: for each additional regulating unit only 10 % of the additional value is taken into account (simultaneity factor)

Examples for similar control loops:

- ① Controller with small drive, without positioner, e.g. RCP 20 with AV 42 P
- ② Controller with large drive, with positioner, e.g. RCP 20 with AV 44 P, XSP 31

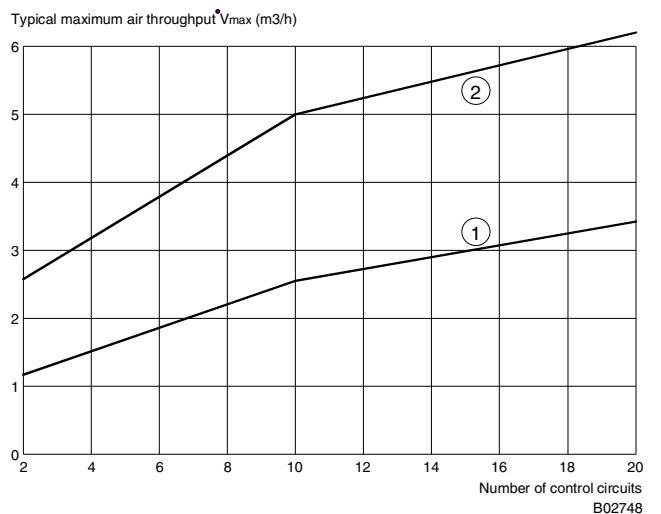

When a complete installation is switched on or when a common setpoint adjustment is carried out, larger quantities of air are required for short periods, i.e. the permissible supply pressure variation is exceeded. The resulting influence on the devices as detailed in 4.3) is usually permissible for these cases.

4.3 Influence of supply pressure on equipment

The transient drop of supply pressure can be estimated for a given distributor manifold by means of the air throughput \dot{V}_{max} according to 2) and the load curves according to 1).

Two groups of malfunctions may occur when the supply pressure is reduced too much:

- a) With many pneumatic devices, only the supply of air is reduced slightly. Regulating devices held closed by pressure which are operated near their design limit may, however, open momentarily because the supply pressure is simultaneously the highest possible pressure output.
- b) A second type of malfunction may occur with devices operating with a stabilised reference pressure (such as setpoint X_s in Centair controllers or zero-reference p_0 in the position controller XSP 31). With control action A, the reference pressure is slightly reduced in correlation with the supply pressure reduction, resulting in an increased pressure output. This additional network load amplifies the entire process (positive feedback) until the device is excited for max. air delivery and will only be stabilised again in the bleed-off phase.

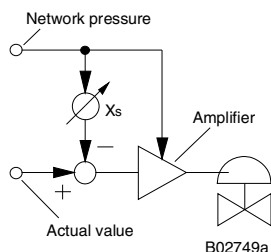

This effect becomes particularly serious if several devices of this type are connected to the same supply-air line or a poorly supplied manifold. In these cases, the positive feedback is transferred to all devices, pressure breaks down in the entire installation and the system may finally end up in a state of continuous oscillation.

Based on this knowledge and practical experience, the following guidelines can be given:

- The air supply to the distributor must be designed such that the pressure drop at air throughput \dot{V}_{max} is not higher than 0,2 bar and that the distributor pressure does not drop below 1,2 bar; this prevents reciprocal influences and transient opening of regulating devices. As a rule, the unloaded reducing unit should therefore be set to 1,4 bar.

- The line from the distributor to the individual consumer must not be looped. For devices with control action A, the piping must not exceed a certain length; otherwise there is a risk that the device will permanently be self-excited.

Max. length of the supply-air line:

di = 4 mm; L_{max} = 10 m

di = 6 mm; L_{max} = 50 m

- The specified line diameters must be stated on the installation diagram. The distributor manifold should have an internal diameter of 12 mm. The connection threads for the compressed-air supply port must match the chosen pipe diameter.

Example: Switch panel for 12 control loops

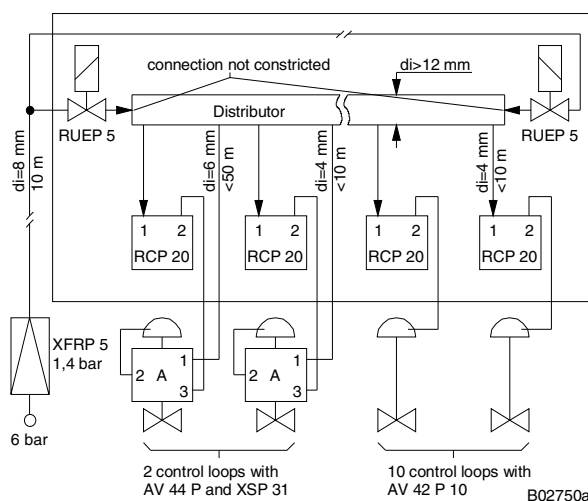

Typical air throughput \dot{V}_{max} at the distributor (see section 4.2)

12 RCP 20	40 l_n/h	each	→ 0,48	} air consumption
12 meas. transducers	33 l_n/h	each	→ 0,40	
2 XSP 31	30 l_n/h	each	→ 0,06	
2 AV 44 P 20	200 l_n/h	each	→ 0,40	} additional demand
10 AV 42 P 10	100 l_n/h	each	→ 1,00	
2 max. air deliv XSP 31	1000 l_n/h	each	→ 2,00	
$\dot{V}_{max} = 4,34 \text{ m}^3/h$				

Characteristic curves of the distributor at $\dot{V}_{max.} = 4,34 \text{ m}^3/h$ (see Section 4.1)

Reducing unit	0,09	bar
Piping $\varnothing=8\text{mm}$; $L=10 \text{ m}$	0,07	bar
2 control valves RUEP 5	0,04	bar
$\Delta p_{tot} =$		0,20 bar

The pressure in the distributor drops from 1,4 bar to 1,2 bar (permissible limit).