



SAUTER modulo system description
Overview of the SAUTER modulo product line
Document number D100402674

Title SAUTER modulo system description
Number D100402674
Revision 07
Version 01
Release

Introduction

Contents

Contents	3
1 Introduction	6
2 System overview	7
2.1 Topology	8
2.2 Description.....	8
3 Building automation	12
3.1 modulo 6 Automation Stations.....	14
3.1.1 Overview.....	14
3.1.2 modu680-AS modular BACnet automation station and web server (EY6AS80F021)	17
3.1.3 modu660-AS modular BACnet automation station (EY6AS60F011)	20
3.2 modulo 6 Integration Solutions	23
3.2.1 Overview	23
3.2.2 modu612-LC IP Coupler for IO-Modules with Webserver (EY6LC12F011).....	25
3.2.3 modu601-LC module for separated I/O module supply (EY6LC01F001)	27
3.2.4 modu602-LC coupling kit I/O modules in cabinet (EY6LC02F001).....	28
3.2.5 modu630-RT BACnet router and hub, B/SC <-> B/IP (EY6RT30F001).....	29
3.3 modulo 6 I/O Modules.....	31
3.3.1 Overview	31
3.3.2 modu630-IO 16 x DI/CI inputs I/O module (EY6IO30F001)	34
3.3.3 modu631-IO 8 x UI(DI/CI/AI) + 8 x DI/CI I/O module (EY6IO31F001)	35
3.3.4 modu650-IO 6 x relay (2A) outputs I/O module (EY6IO50F001)	36
3.3.5 modu670-IO 8 x DI/CI/DO(OC) + 8 x DI/CI I/O module (EY6IO70F001)	37
3.3.6 modu671-IO 8 x AO + 8 x DI/CI IO-Module (EY6IO71F001)	38
3.3.7 modu672-IO 4xAO, 4xDO(OC), 4xUI(DI/CI/AI) IO-Module (EY6IO72F001).....	39
3.3.8 modu600-LO, operating and indicating unit for I/O modules (EY6LO00F001)	41
3.4 modulo 6 Communication Modules	43
3.4.1 Overview	43
3.4.2 modu620-CM Modbus-RTU (RS-485) Communication Module (EY6CM20F011).....	44
3.4.3 modu630-CM M-Bus communication module (EY6CM30F031)	46
3.5 modulo 6 Web Operation and Services.....	49
3.5.1 moduWeb Unity	49
3.6 modulo 6 - Data integrity	53
3.6.1 Overview	53
4 Room automation	56
4.1 ecos 5 room automation	56
4.1.1 ecos500, ecos502, ecos504/505 Room Automation Station	56
4.1.2 ecoUnit room operating units.....	59

4.1.3	ecoUnit-Touch room operating units	61
4.1.4	Remote ecoLink I/O modules	62
5	Building Management and Control	65
5.1	SAUTER Vision Center – central building management and visualisation	65
5.2	SAUTER Engineering Suite	67
6	System Integration	68
6.1	Overview	69
6.2	modulo 5	69
6.3	Legacy (novaNet)	69
6.4	Fieldbus, SLC	70
6.5	Industrial	70
6.6	IoT and the Cloud	70
6.7	Network services	70
7	Integrated CASE Suite service	71
7.1	CASE Builder	72
7.2	CASE Engine	72
7.3	CASE Vision	73
7.4	CASE Library Management	73
7.5	Components	73
7.5.1	CASE VAV	73
7.5.2	CASE VAV Factory	74
7.5.3	CASE TPC (Touch Panel Configurator)	74
7.5.4	CASE Drives	74
7.5.5	CASE Sensors	74
7.6	CASE Tools	74
7.6.1	CASE Export	74
7.6.2	CASE Export BACnet	75
7.6.3	CASE Export novaNet	75
7.6.4	CASE Import	75
7.6.5	BACnet Server Configurator	75
7.7	Communication	75
7.7.1	CASE HWC (hardware commissioning)	75
7.7.2	CASE Sun	75
7.7.3	novaMit29x	76
7.7.4	Virtual Port Configurator	76
8	Further information	77
8.1	BACnet Communication Protocol	77
8.1.1	BACnet	77
8.1.2	Native BACnet	78
8.1.3	BACnet/IP	78
8.1.4	BACnet/MSTP	79

Introduction

8.1.5	BACnet/SC	80
8.2	MQTT Communication Protocol	83
8.3	8.3 IEC 62443.....	85
8.4	Port-based Network Access Control, IEEE 802.1X.....	85
	Glossary	88
	List of Figures.....	91
	List of tables	92

1 Introduction

EY-modulo 6 is the high-end building management system from SAUTER. With new automation stations and new system topology, modulo 6 offers extended flexibility and scalability. The SAUTER modulo system family covers all applications in regulation and control technology from HVAC, building and energy management to flexible solutions in integrated room automation.

Welcome to the age of BIoT, Building IoT.

modulo 6 moves the **digital transformation** of building automation one step further. While the previous generation already provided innovative Internet-based functions such as **BACnet/IP**, email notifications and embedded web servers, modulo 6 extends modularity and interoperability via the Internet and the cloud by permitting the relocation of I/O and COM modules via the network. The standard communication of modulo 6 is based on the standard BACnet/IP protocol. Special functions such as email notifications, text messages and network synchronisation as well as the web server and **RESTful API** are based fully on IP communication.

Digitalisation, and in particular the Internet of Things (IoT), opens new applications in the areas of data processing in the cloud, operation via end devices such as smartphones and tablets, integration of communicative, smart sensors and networking with cloud services such as data analytics or voice services such as Amazon Alexa and Google Home. However, they also involve new threats. For this reason, security was the main focus when developing modulo 6. The **security by design** policy, following the **IEC 62443** standard, is a key attribute of the modulo 6 development, resulting in a set of hardware and software features, all oriented to make the use of modulo 6 as safe as possible.

Tooling is also a critical aspect of the realisation of building automation solutions. Productivity is a key factor for efficient, error-free project processing. The new version (4) of **CASE** is also downwards-compatible and enables the migration of existing modulo 5 projects to modulo 6.

SAUTER Vision Center (SVC) is SAUTER's powerful solution for building and energy management. SVC also offers important functions for maintenance management and data analysis. SAUTER Vision Services provide these functions in the cloud.

SAUTER Cloud Solutions will provide new ways of working and interacting with the building environment. New solutions are provided “as a Service”, both for technicians and end users. The **SAUTER Portal** offers access to immediately usable functions and libraries and enables all devices to be managed via the cloud. **Mobile Building Solutions** ensures the operation of the heating and climate functions, including lighting and sun shading in rooms and apartments, via smartphone and tablet.

Exciting new possibilities are within reach with modulo 6.

System overview

2 System overview

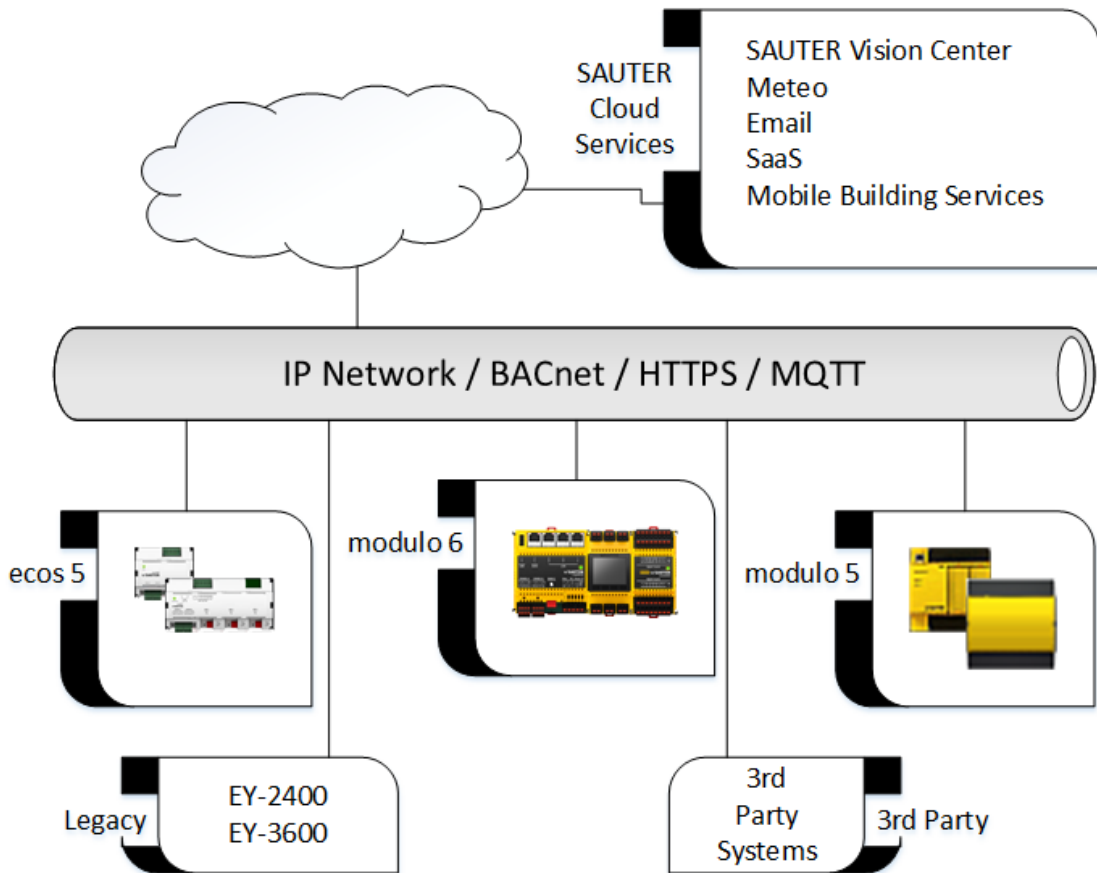

2.1 Topology

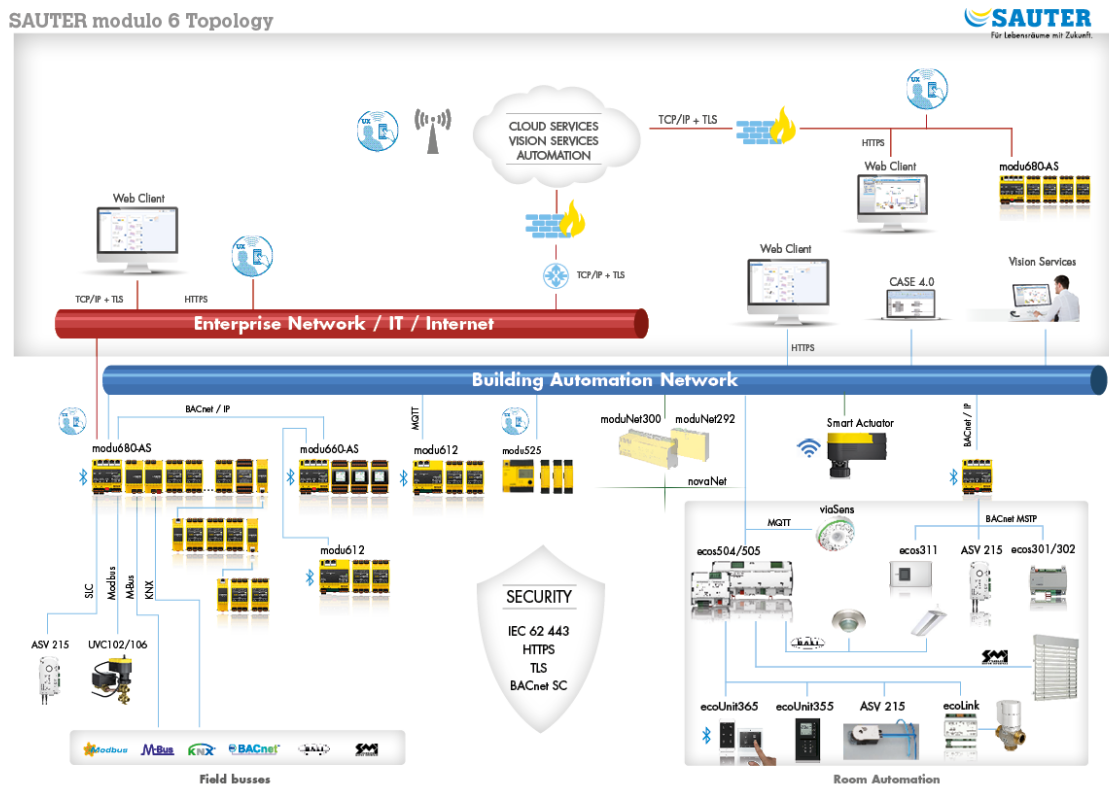

2.2 Description

modulo 6 provides the solutions to respond to these needs in the age of the Internet of Things and the 4.0 industrial revolution. The new controllers provide enhanced automation power. Furthermore, the connectivity between modulo 6 and modulo 5 is secured by BACnet/IP interoperability.

modulo 6 in the era of digitalisation

modulo 6 Automation Stations are the foundation of the complete modulo 6 system family for interconnected regulation, control and monitoring of building automation systems (BAS).

The system includes the following product lines:

- Sauter modulo 6 product line of modular Automation Stations and modules
- Sauter Vision Center building and energy management control system
- SAUTER CASE Suite engineering software
- SAUTER solution libraries
- Intelligent actuators
- Intelligent sensors and terminals
- SAUTER Cloud solutions

System overview

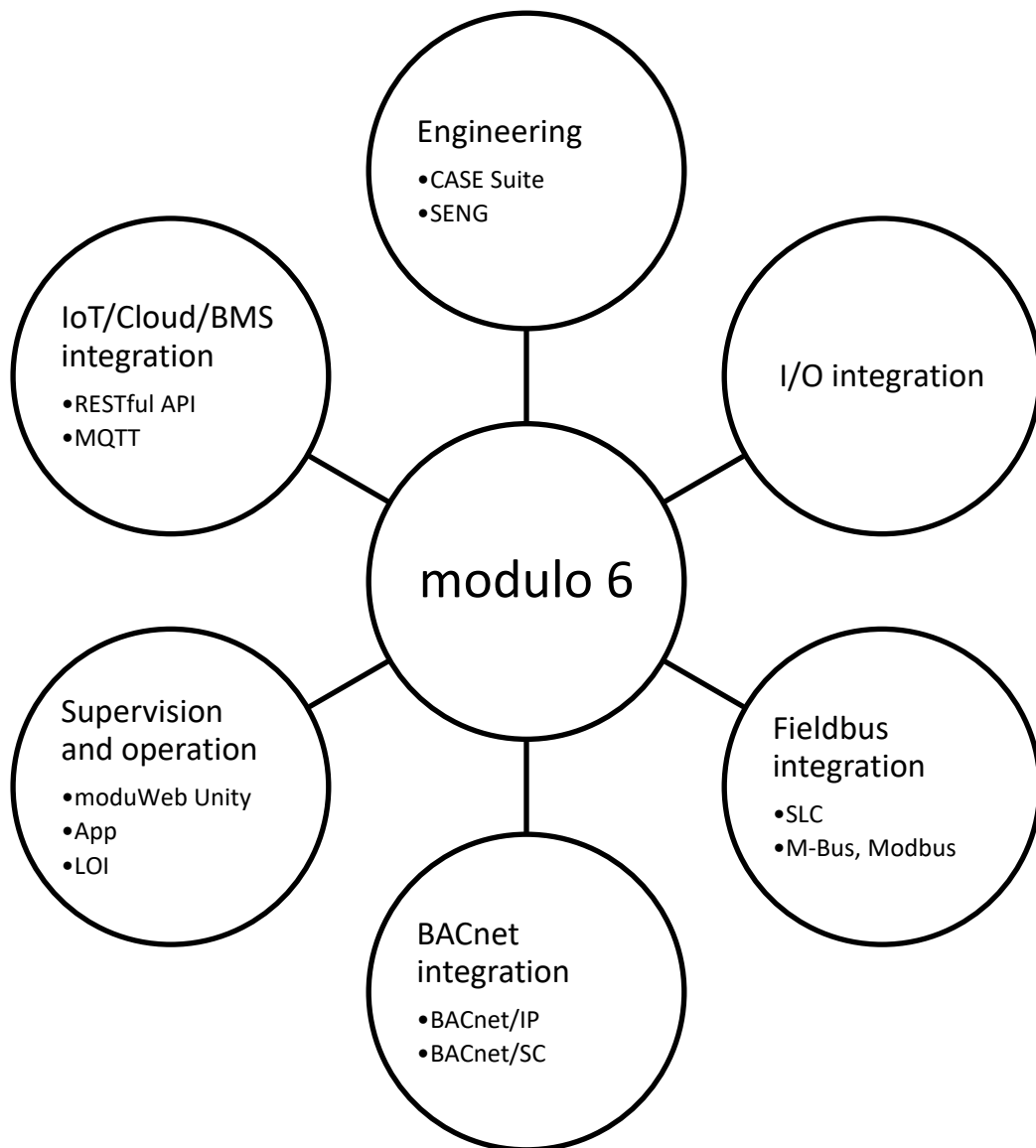

Figure 1 modulo 6 connectivity.

modulo 6 takes full advantage of digital connectivity, wired or wireless. The Ethernet network and the Internet protocol are the backbone of the BAS and IoT integration. These days, (W)LAN is ubiquitous and provides easy integration capabilities with the growing number of IoT and Cloud Solutions. “BIoT” or “Building IoT” refers to building automation integrated into the Internet of Things.

BACnet/IP is used as the standard, open communication protocol between BAS devices over the network. The BACnet-certified SAUTER modulo 6 products enable the reliable integration of BACnet-certified products from SAUTER and other manufacturers. The IoT protocol MQTT ensures easy yet secure communication between remote I/O modules in the network and the automation stations, as well as communication with cloud services.

modulo 6: compact & modular system

The **modu680-AS** station is the flagship of the modulo 6 Automation Stations. It is intended for the regulation and control of both HVAC primary energy preparation applications as well as IRC demand applications. Two different, separate networks enable the clear separation of the exchange of operation data for the building automation and the requirements of external systems, e.g. BMS or web clients. The large capacity and the multi-process capability enable multiple applications to be implemented with a single controller. Thanks to the modular structure and the flexibility of the fitting, any topology is possible. Up to 24 modules can be directly attached. Up to 5 communication modules for fieldbus integration can be directly attached. Integration of SAUTER devices using the SAUTER Local Communication bus (SLC) and a Modbus RTU or BACnet/MSTP is directly available in the station.

The **modu660-AS** station is the optimised station supporting the core functionality for more decentralised topologies. Up to 24 modules can be attached to the station, and also over the SLC Interface. The station remains tightly integrated over BACnet.

The **modu612-LC** provides additional topology flexibility to remotely communicate with I/O modules over LAN as well as over the cloud. It also enables direct communication with cloud services. The **modu612-LC** and the I/O modules attached to it are assigned to an Automation Station as part of its dataset.

modulo 6 devices are built using an industrial-grade, high-performance CPU. They have been designed for long-term availability and applications in automation areas using multiple communication protocols.

modulo 6 hardware reduces installation and commissioning overheads thanks to the:

- Compact, standardised form factor (DIN 43880)
- Frontal slide-in assembly with spring contacts
- Protection cover for I/O bus termination
- Pluggable, push-in spring connectors
- **modu602-LC** line-break kit
- **modu601-LC** power injection module
- **modu600-LO** universal operation and indication unit

The **modu600-LO** Local Operation and Indication unit is a universal LOI that can be set on any of the modu6** I/O modules. With its simplified user interface and a high-resolution colour LCD screen, the unit enables the easy visualisation of the I/O module and its signals and allows to operate the output signals directly. The same function can be done with the mobile App¹ via the Bluetooth interface.

moduWeb Unity and the Visualization of Things

moduWeb Unity is the embedded web server accessible with any HTML5 web browser. It includes most of the functions of PC-based SCADA systems but is directly accessible via the web server. The core functionality provides any user with an easy-to-use

¹ Sauter modulo 6 App for iOS and Android. Available on AppleStore and GooglePlay.

System overview

graphical user interface for interacting with the system. Buildings and spaces within a building, such as complete floors or individual rooms, as well as technical installations, can be graphically represented and operated intuitively. BACnet objects are mapped structurally. Specialised views for schedules, calendars and Trend Logs make day-to-day use of these functions a piece of cake. Alarms have their dedicated view and can be notified to registered users by e-mail or text messaging.













moduWeb Unity facilitates the commissioning of all IP-capable modulo 6 devices. Setting up the station is made easy, even before the final application is loaded. Part of the commissioning includes the security settings such as user creation and rights assignment for the station and web server, enabling communication interfaces and protocols, loading encryption certificates or application backup and restoration.

modulo 6 and Cybersecurity



The Internet has opened up a new universe of possibilities but has also brought a new range of threats with it. modulo 6 has been designed with this in mind from the very beginning. IEC 62443 has been used as a guideline. Sensitive data is stored in encrypted form, while TLS technology is used for communication encryption.

Further features of modulo 6 also provide additional security. **modu680-AS** has an integrated network separation for Internet and building automation. Interfaces that are not being used can be deactivated by authorised users. Access control lists (black list, white list) can also be set up to limit communication between devices.

3 Building automation

modulo 6 Automation stations				Page 14	
	EY6AS80F021 modu680-AS Modular BACnet automation station and web server		EY6AS60F011 modu660-AS modular BACnet automation station		
modulo 6 Integration Solutions				Page 23	
	EY6LC12F011 modu612-LC IP coupler for I/O modules with web server		EY6LC01F001 modu601-LC Module for separate I/O module supply		EY6LC02F001 modu602-LC Coupling kit for I/O modules in the cabinet
	EY6RT30F001 modu630-RT BACnet router and hub, B/IP <-> B/SC				
modulo 6 I/O Modules				Page 31	
	EY6IO30F001 modu630-IO 16 x DI/CI inputs I/O module		EY6IO31F001 modu631-IO 8 x UI(DI/CI/AI) and 8 x DI/CI I/O module		EY6IO50F001 modu650-IO 6 x relay (2A) outputs I/O module
	EY6IO70F001 modu670-IO 8 x DI/CI/DO (OC) and 8 x DI/CI I/O module		EY6IO71F001 modu671-IO 8 x AO and 8 x DI/CI I/O module		EY6IO72F001 modu672-IO 4xAO, 4xDO(OC), 4xUI(DI,CI,AI) IO-module
	EY6LO00F001 modu600-LO Local operating and indicating unit for I/O modules				



Building automation

modulo 6 Communication Modules		Page 43	
	EY6CM20F011 modu620-CM Modbus-RTU (RS-485) communication module		EY6CM30F031 modu630-CM M-Bus communication module
modulo 6 - Data integrity		Page 53	
	EY6BM15F011 modu615-BM Building Data Integrity Manager		

3.1 modulo 6 Automation Stations

modulo 6 includes two BACnet Building Controllers.

3.1.1 Overview

		
Reference number	EY6AS80F021	EY6AS60F011
Name	modu680-AS	modu660-AS
Description	Modular BACnet automation station and web server	modular BACnet automation station
Certification	BACnet BCC as B-BC, BTL CE	BACnet BCC as B-BC, BTL CE
BACnet objects	Max. 1600 HW-IO	Max. 800 HW-IO
Power supply	24 V _{DC} +/-10%	24 V _{DC} +/-10%
Inputs and outputs	Point to Point with modu6**-I/O modules Fieldbus with modu6**-CM modules	Point to Point with modu6**-I/O modules Fieldbus with modu6**-CM modules
Modules	Max. 24 modules overall ² Max. 5 fieldbus modules Max. 2 modu602-LC kits	Max. 24 modules overall ² Max. 5 fieldbus modules Max. 2 modu602-LC kits
Connections	Printed circuit board connector for plug-in spring connectors	Printed circuit board connector for plug-in spring connectors
Processes	Max. 4 independent programs	Max. 4 independent programs
Cycle time	Adjustable for each process Min. 50 ms	Settable, by process Min. 50 ms
Interfaces	1 x Ethernet RJ45 10/100 3 x Ethernet RJ45 10/100 switched (daisy chain) 1 x RS-485 for SLC (D+, D-, C, +24VDC) 1 x RS-485 for configurable protocol (D+, D-, C) 1 x USB Type A v2.0 500mA 1 x microSD 1 x Bluetooth	- 2 x Ethernet RJ45 10/100 switched (daisy chain) 1 x RS-485 for SLC (D+, D-, C, +24VDC) - - 1 x USB Type A v2.0 500mA 1 x microSD 1 x Bluetooth
Alive Signal	0, 1...5 Hz Max. 24 V	0, 1...5 Hz Max. 24 V
RTC	Yes CR2032 battery (exchangeable)	Yes CR2032 battery (exchangeable)
Dimensions	W (↔) 93 mm (5 TE) L (↕) 101 mm H (↑) 59 mm	W (↔) 93 mm (5 TE) L (↕) 101 mm H (↑) 59 mm

² Requires modu601-LC

Building automation**Important information**

modu680-AS and **modu660-AS** can power-up up to 12 modules, including the LOI on I/O modules. To power-up the maximum supported 24 modules, the **modu601-LC** module is needed.

The SD-Card support includes hot-plugging the SD-Card. The SD card can also be changed during operation. The data is stored locally and then synchronised with the new storage medium at a later time. The local storage capacity is limited to 64 MB which under normal load can represent up to 3 days.

The battery is only for powering the internal clock. The battery is designed for a serviceable life of up to 10 years but it can be replaced. This is done by removing the cover and inserting a new battery. Be aware of the danger of the explosion of the cell battery during removal if short-circuited!

The SLC interface does not support older versions of ecoLink modules. Check compatibility when upgrading older installations. Check the list of supported devices below:

Device	Critical characteristic	Production
EY-EM510, EY-EM511, EY-EM512, EY-EM520, EY-EM521, EY-EM526	Firmware V1.21 and newer	Since June 2015
EY-EM522	Firmware V1.02 and newer	Since September 2014
EY-EM514, EY-EM515, EY-EM523, EY-EM527	Any	
EY-EM580	Index G	2017 and newer
EY-CM581		

Licenses

The following licence references enable the activation of functions on the automation station (FX: Function eXtension):

Reference	Function
Y6FX02F001	MQTT Client Activation of MQTT Client and MQTT COmmissioning Tool
Y6FX02F002	MQTT Broker/Client Activation of MQTT Broker, Client und MQTT COmmissioning Tool
Y6FX03F001	802.1x/RADIUS Supports the 802.1x standard for PNAC.
Y6FX04F001	BACnet/SC datalink activation

Building automation

3.1.2 modu680-AS modular BACnet automation station and web server (EY6AS80F021)

Reference number EY6AS80F021
Printed name modu680-AS



Technical data

Power supply	24 V _{DC} +/- 10%
CPU	ARM™ Cortex™A8
Frequency	1 GHz
RAM (DDR3)	512 MB
Flash (NAND)	512 MB
OS	Linux-based v. 4.9 or newer
Ethernet	10/100 1 x uplink 3 x downlink (switched)
Link between modules	9 side springs, gold coated, right side only
Connections	Printed circuit board connector for plug-in spring connectors
USB	Type A, v2.0 max. 500mA, max. 2.5W
RS-485	1 x SLC, 4-wire (D+, D-, C, 24VDC) 1 x Modbus 3-wire (M+, M-, GND)
Bluetooth	4.0, BLE Interface for modulo 6 App
Memory	μSD -Card, microSD-SLC
Modules	Max. 24 modules overall ³ Max. 5 fieldbus modules Max 2 modu602-LC kits
BACnet profile	B-BC, B-BBMD, B-SCHUB
I/O	Up to 1600 HW-I/Os from modu6**-IO, ecoLink or Fieldbus
BACnet objects	Objects Standard: AI, AO, BI, BO, MI, MO, PC, LO AV, BV, MV, PIV LOOP, EE, NC SCHED, CAL EL, TL PRG, DEV Proprietary: DIM_O, BLND_O, BLND_O2, OPT_C, OPT_H

Protocols	BACnet/IP BACnet/MSTP SMTP, HTTPS, SMPP MQTT (Broker, Client)
Web server	moduWeb Unity
WS features⁴	Visualisation of trades and layouts BACnet Alarm Management Structured View Object Management User Management System Settings RESTful API
On-board security	Access Control List, encryption TLS, password protection

³ Requires modu601-LC

⁴ License(s) activation may be required

LED	
	● Power off
	● Operational
	●● CASE Sun identification
	● No Plan loaded
	●● In configuration, restart/download ongoing
	●●● Internal device error
	● Start-up mode
	● Low battery
	●● LED test

Description

modu680-AS is the flagship of the modulo 6 stations. This high-performance Automation Station is equipped with an ARM Cortex™ A8 processor allowing the execution of different automation processes in parallel and thus realising several applications on the same device. As a BACnet-certified Building Controller, the station provides a reliable and interoperable solution based on the standard protocol for building automation in native form.

Up to 24 additional modules can be attached to the station in different topologies. Digital and analogue signals as well as all the most relevant fieldbus protocols can be integrated directly into the station or using additional modules. The modules can be directly attached to the station, or split into lines with the **modu602-LC** kit within a cabinet and even further away with the **modu612-LC** over the IT network.

Two RS-485 bus connections support additional fieldbus connectivity. On one hand, the SLC interface provides additional extension capabilities for mid-range remote ecoLink modules, ecoUnit terminals or ASV drivers. On the other hand, Modbus RTU connectivity is supported via the second connector. Further protocols will be supported later on, such as BACnet/MSTP.

With the two independent network links, the **modu680-AS** can manage two separate networks, one for the local automation (LAN), and another attached to the general-purpose IT infrastructure with access to the Internet (WAN). The access lists, password-protected access and encryption of data provide the necessary security mechanisms for the solution.

The device includes a microSD card interface to extend the storage capability for historical data, audit trails, backups, etc. An additional USB port also allows further removable storage media to be connected.

The station includes the **moduWeb Unity** Embedded Building Management system. The HTML5-embedded web server provides an advanced solution for local commissioning, visualisation and control. The functionality can be extended to make a full-featured, local management system for small and mid-sized projects out of the **modu680-AS**.

Commissioning and maintenance with the **modulo 6 App** are made easy over the wireless Bluetooth connection that provides access to the automation station and the IO-

Building automation

modules. It allows the visualisation of modules and signals on the terminals as well as other configuration possibilities. As with **modu600-LO**, the signals on the I/O modules can be overridden with the App over the Bluetooth connection.

The “Alive” signal can be used to monitor overall system functionality by another station.

The new CASE Suite paves the way for highly efficient engineering. A large library of pre-defined solutions provides proven automation solutions for HVAC applications.

Maximum configuration

- Up to 2 line breaks with the modu602-LC kit
- Up to 24 modules overall (using modu601-LC)
- Up to 5 Fieldbus modules directly attached to the station
- Additional extension capability over SLC bus with up to 12 devices, including ASV drives, ecoLink modules, ecoUnit terminals or FCCP200 terminals
- Line terminator delivered with the station (to be set up on the last module)
- microSD interface
- USB 2.0 interface
- Bluetooth interface

3.1.3 modu660-AS modular BACnet automation station (EY6AS60F011)

Reference number EY6AS60F011

Printed name modu660-AS



Technical data

Power supply	24 V _{DC} +/- 10%
CPU	ARM™ Cortex™A8
Frequency	1 GHz
RAM (DDR3)	512 MB
Flash (NAND)	512 MB
OS	Linux-based v. 4.9 or newer
Ethernet	10/100 2 x downlink (switched)
Link between modules	9 side springs, gold coated, right side only
Connections	Printed circuit board connector for plug-in spring connectors
USB	Type A, v2.0 max. 500mA, max. 2.5W
RS-485	1 x SLC, 4-wire (D+, D-, C, 24 V)
Bluetooth	4.0, BLE Interface for modulo 6 App
Memory	μSD -Card, microSD-SLC
Modules	Max. 24 modules overall ⁵ Max. 5 fieldbus modules Max 2 modu602-LC kits
BACnet profile	B-BC, B-BBMD, B-SCHUB
I/O	Up to 800 HW-I/Os from modu6**-IO, ecoLink or Fieldbus
BACnet objects	Objects Standard: AI, AO, BI, BO, MI, MO, PC, LO AV, BV, MV, PIV LOOP, EE, NC SCHED, CAL EL, TL PRG, DEV Proprietary: DIM_O, BLND_O, BLND_O2, OPT_C, OPT_H

Protocols	BACnet/IP BACnet/MSTP SMTP, HTTPS, SMPP MQTT (Broker, Client)
Web server	moduWeb Unity
WS features⁷	Visualisation of trades and layouts BACnet Alarm Management Structured View Object Management User Management System Settings RESTful API
On-board security	Access Control List, encryption TLS, password protection
LED	<ul style="list-style-type: none"> ● Power off ● Operational ●● CASE Sun identification ● No Plan loaded ●● In configuration, restart/download ongoing ●●● Internal device error ● Start-up mode ● Low battery ●● LED test

⁵ Requires modu601-LC

⁶ Requires modu660-CM

⁷ License(s) activation may be required

Building automation

Description

modu660-AS is the little brother of **modu680-AS**. This optimised Automation Station is also equipped with an ARM Cortex™ A8 processor enabling the execution of different automation processes in parallel and thus realising several applications on the same device. As a BACnet-certified Building Controller, the station provides a reliable and interoperable solution based on the standard protocol for building automation in native form.

Up to 24 additional modules can be attached to the station in different topologies. Digital and analogue signals as well as all the most relevant fieldbus protocols can be integrated directly into the station or using additional modules. The modules can be directly attached to the station, or split into lines with the **modu602-LC** kit within a cabinet and even further away with the **modu612-LC** over the IT network.

The RS-485 bus connection supports the SLC interface, which provides additional extension capabilities for mid-range remote ecoLink modules, ecoUnit terminals or ASV drivers.

modu660-AS includes a two-port switched connection for the local automation (LAN), supporting daisy-chain topology. The access lists, password-protected access and encryption of data provide the necessary security mechanisms for the solution.

The device includes a microSD card interface to extend the storage capability for historical data, audit trails, backups, etc. An additional USB port also allows further removable storage media to be connected.

The station includes the **moduWeb Unity** Embedded Building Management system. The HTML5 embedded web server provides an advanced solution for local commissioning, while visualisation and management are available as an option.

Commissioning and maintenance with the **modulo 6 App** are made easy over the wireless Bluetooth connection that provides access to the automation station and the IO-modules. It allows the visualisation of modules and signals on the terminals as well as other configuration possibilities. As with **modu600-LO**, the signals on the I/O modules can be overridden with the App over the Bluetooth connection.

The “Alive” signal can be used to monitor overall system functionality by another station.

The new CASE Suite paves the way for highly efficient engineering. A large library of pre-defined solutions provides proven automation solutions for HVAC applications.

Maximum configuration

- Up to 2 line breaks with the **modu602-LC** kit
- Up to 24 modules overall (using **modu601-LC**)
- Up to 5 fieldbus modules directly attached to the station

Building automation



- Additional extension capability over SLC bus with up to 12 devices, including ASV drives, ecoLink modules, ecoUnit terminals or FCCP200 terminals
- Line terminator delivered with the station (to be set up on the last module)
- microSD interface
- USB 2.0 interface
- Bluetooth interface

Building automation

3.2 modulo 6 Integration Solutions

The modulo 6 integration solutions provide additional flexibility in the configuration of the automation set-up. The **modu602-LC** kit allows the splitting of I/O module lines into different rows within the cabinet, providing short-range connectivity over a point-to-point connection. **modu612-LC**, on the other hand, enables long-range connections to be set up via the IP network. **modu601-LC** provides additional flexibility, facilitating a power supply to the I/O modules during short station interruptions, or even having a separated supply. Finally, **modu630-RT** is a BACnet router and hub to ensure interoperability between BACnet/IP and BACnet/SC networks.

3.2.1 Overview

			
Reference number	EY6LC12F011	EY6LC01F001	EY6LC02F001
Name	modu612-LC	modu601-LC	modu602-LC
Description	IP coupler for I/O modules with web server	Module for separate I/O module supply	Coupling kit for I/O modules in the cabinet
Certification	–	–	–
BACnet objects	–	–	–
Power supply	24 V _{DC} +/-10%	24 V _{DC} +/-10%	-
Inputs and outputs	Point to Point with modu6**-I/O modules Fieldbus with modu6**-CM modules	Point to Point with modu6**-I/O modules Fieldbus with modu6**-CM modules	Point to Point with modu6**-I/O modules
Modules	Max. 24 modules overall ⁸ Max. 5 fieldbus modules Max. 2 modu602-LC kits (lines)	Max. 12 I/O modules	Max. 12 I/O modules
Processes	–	–	–
Cycle time	–	–	–
Interfaces	I/O bus 2 x Ethernet RJ45 10/100 switched (daisy chain, ...) 1 x Bluetooth	1 x RJ45 internal bus Straight-shielded RJ45 cable only!	1 x RJ45 internal bus Straight-shielded RJ45 cable only!
RTC	CR2032 battery (exchangeable)	–	–
Dimensions	W (↔) 93 mm (5 TE) L (↓) 97 mm H (↑) 59 mm	W (↔) 56 mm (3 TE) L (↓) 97 mm H (↑) 59 mm	W (↔) 27 mm (1.5 TE) L (↓) 97 mm H (↑) 59 mm

⁸ Requires modu601-LC

	
Reference number	EY6RT30F001
Name	modu630-RT
Description	BACnet router and hub, B/IP <-> B/SC
Certification	BACnet BCC as B-RT, B-SCHUB, B-BBMD, BTL CE
BACnet objects	Standard: DEV, NP, FL
Power supply	24 V _{DC} +/-10%
Inputs and outputs	-
Modules	-
Processes	-
Cycle time	-
Interfaces	1 x Ethernet RJ45 10/100 3 x Ethernet RJ45 10/100 switched (daisy chain, ...) 1 x Bluetooth
RTC	CR2032 battery (exchangeable)
Dimensions	W (↔) 93 mm (5 TE) L (↕) 97 mm H (↓) 59 mm

Building automation

3.2.2 modu612-LC IP Coupler for IO-Modules with Webserver (EY6LC12F011)

Reference number EY6LC12F011
Printed name modu612-LC



Technical data

Power supply	24 V _{DC} +/- 10%
CPU	ARM™ Cortex™ A8
Frequency	1 GHz
RAM (DDR3)	512 MB
Flash (NAND)	512 MB
OS	Linux-based v. 4.9 or newer
Ethernet	10/100 2 x downlink (switched)
Link between modules	9 side springs, gold coated, right side only
Connections	Printed circuit board connector for plug-in spring connectors
USB	Type A, v2.0 max. 500mA, max. 2.5W
Bluetooth	4.0, BLE Interface for modulo 6 App
Memory	μSD -Card, microSD-SLC
Modules	Max. 24 modules overall ⁹ Max. 5 fieldbus modules Max 2 modu602-LC kits
Protocols	MQTT (client) HTTPS
Web server	moduWeb Unity
WS features¹⁰	User Management System Settings RESTful API
On-board security	Access Control List, encryption TLS, password protection
LED	<ul style="list-style-type: none"> ● Power off ● Operational ●● CASE Sun identification ● No Plan loaded ●● In configuration, restart/download ongoing ●●● Internal device error ● Start-up mode ● Low battery ●● LED test

⁹ Requires modu601-LC

¹⁰ License(s) activation may be required

Description

modu612-LC is a Link Coupler allowing the remote installation of COM- and I/O modules and allowing communication with a Building Controller over the IP network, for example, a **modu680-AS**, or to the SAUTER Cloud. The **modu612-LC** supports the same number of COM and I/O modules (24) as the Building Controller and is intended to extend the number of data points controlled by a Building Controller.

modu612-LC establishes a direct connection to a higher-level modulo 6 automation station (**modu680-AS**, **modu660-AS**) or to the SAUTER Cloud, where the IO signals or fieldbus data points are mapped to BACnet objects. The values of sensors at the station are transmitted via the persistent connection or the control signals of the station are transmitted to the terminals of the IO modules or fieldbus data points. Communication between **modu612-LC** and the control unit is encrypted.

Like the modulo 6 automation stations, **modu612-LC** supports a Bluetooth connection that can be used together with the **modulo 6 app** to monitor and override the IO signals, as an alternative to the **modu600-LOs**. Access to the **modulo 6 app** is possible with the users defined for **moduWeb Unity**. **modu612-LC** has its own instance of **moduWeb Unity**, which can be used to make the **modu612-LC** settings.

Maximum configuration

- Up to 2 line breaks with the **modu602-LC** kit
- Up to 24 modules overall (using **modu601-LC**)
- Up to 5 fieldbus modules directly attached to the station
- Line terminator delivered with the station (to be set on the last module)
- USB 2.0 interface
- Bluetooth interface

3.2.3 modu601-LC module for separated I/O module supply (EY6LC01F001)

Reference number EY6LC01F001

Printed name modu601-LC



Technical data

Power supply	24 V _{DC} +/- 10%
Link between modules	7 side springs, gold coated, both sides

Modules	Overall, limited by station Max. 24 W power consumption
----------------	--

Description

modu601-LC is a small module which gives the possibility of extending the number of modules of an Automation Station beyond the limit of 12 up to the maximum of 24, by providing the necessary power for the additional modules. It provides also the possibility of having an alternative power supply to the I/O modules instead of the Automation Station. The module shall be powered by another power source and therefore secure a power supply to the I/O modules which do not rely on the Building Controller. Default output values can be defined for the I/O modules in the application with the engineering tool. The default values apply when the station is not operational, for example during an update process. LOI overrides are maintained or can be applied while the station is not operational.

3.2.4 modu602-LC coupling kit I/O modules in cabinet (EY6LC02F001)

Reference number EY6LC02F001
 Printed name modu602-LC



Technical data

Link between modules	7 side springs, gold coated, left or right side respectively
Link	RJ45 on each module for this purpose only. Straight and shielded RJ45 cables with up to 3m length overall for an Automation Station
Modules	Max. 12 I/O modules

Kit	1 x send module 1 x receive module
------------	---------------------------------------

Description

The **modu602-LC** kit is composed of two small modules, a sender and a receiver. They must be interconnected over their RJ45 connector with a shielded RJ45 (AWG 24) cable. The first module is set at the end of the line, replacing the termination cover. The second module is the beginning of a new arrangement of I/O modules, terminated with the termination cover or a second kit.

Up to two **modu602-LC** kits can be used on a single Automation Station (**modu680-AS**, **modu660-AS**) or a **modu612-LC** with up to 3m overall cable length.



Do not use crossed RJ45 cables.
 Do not bind to LAN infrastructure. This will damage your network devices.

3.2.5 modu630-RT BACnet router and hub, B/SC <-> B/IP (EY6RT30F001)

Reference number EY6RT30F001
Printed name modu630-RT



Technical data

Power supply	24 V _{DC} +/- 10%
CPU	ARM™ Cortex™ A8
Frequency	1 GHz
RAM (DDR3)	512 MB
Flash (NAND)	512 MB
OS	Linux-based v. 4.9 or newer
Ethernet	10/100 1 x uplink 3 x downlink (switched)
Protocols	BACnet/IP BACnet/SC (IPv4, IPv6)
BACnet/SC	BACnet/SC Hub, Router
BACnet profile	B-RTR, B-BBMD, B-SCHUB

On-board security	TLS 1.3
LED	<ul style="list-style-type: none"> ● Power off ● Operational ●● CASE Sun identification ● No Plan loaded ●● In configuration, restart/download ongoing ●●● Internal device error ● Start-up mode ● Low battery ●● LED test

Description

The **modu630-RT** is a BACnet device supporting BACnet routing and BACnet/SC hub functionalities, which enable the integration between BACnet/IP and BACnet/SC networks. Based on WSS and TCP, BACnet/SC supports the TLS standard and all information exchanged over this protocol is encrypted. With the combined support on the same device of two datalinks, this device provides the necessary flexibility to realise new, secured topologies or to integrate existing, less-safe networks safely. For example, an installation done with devices supporting BACnet/IP only can be connected to an SVC in the cloud using BACnet/SC for the transit in the internet. Also, migrations from BACnet/IP to BACnet/SC can be done step by step by securing interoperability between both networks with the router.



The **modu630-RT** also supports the Hub functionality for up to 10 BACnet/SC nodes. This function is necessary for a BACnet/SC network. More technical information on BACnet/SC can be found in § 8.1.5 BACnet/SC



Maximum configuration

- BACnet Router (B-RT)
- BACnet SC Hub (B-SCHUB)
- BACnet BBMD (B-BBMD)
- Router: SC↔IP routing
- Hub: up to 10 Nodes

3.3 modulo 6 I/O Modules

3.3.1 Overview

			
Reference number	EY6IO30F001	EY6IO31F001	EY6IO50F001
Name	modu630-IO	modu631-IO	modu650-IO
Description	16 x DI/CI inputs I/O module	8 x UI(DI/CI/AI) and 8 x DI/CI I/O module	6 x relay (2A) outputs I/O module
Connections	4 pluggable, 8-position push-in spring connectors	4 pluggable, 8-position push-in spring connectors	6 pluggable, 2-position push-in spring connectors
Inputs	16 x DI/CI	8 x UI (DI/CI/AI) 8 x DI/CI	None
Outputs	None	None	6 x DO (relay)
Dimensions	W (↔) 56 mm (3 TE) L (↓) 100 mm H (↑) 59 mm	W (↔) 56 mm (3 TE) L (↓) 100 mm H (↑) 59 mm	W (↔) 56 mm (3 TE) L (↓) 100 mm H (↑) 59 mm

			
Reference number	EY6IO70F001	EY6IO71F001	EY6IO72F001
Name	modu670-IO	modu671-IO	modu672-IO
Description	8 x DI/CI/DO (OC) and 8 x DI/CI I/O module	8 x AO and 8 x DI/CI I/O module	4xAO, 4xDO(OC), 4xUI(DI/CI/AI) IO-module
Connections	4 pluggable, 8-position push-in spring connectors	4 pluggable, 8-position push-in spring connectors	4 pluggable, 8-position push-in spring connectors
Inputs	8 x DI/CI/DO(OC) 8 x DI/CI	8 x DI/CI	4 x UI (DI/CI/AI)
Outputs	see above	8 x AO (0(2)...10V)	4 x (AO(0(2)...10 V, 0(4)...20mA) 4 x DO(OC)
Dimensions	W (↔) 56 mm (3 TE) L (↕) 100 mm H (↑) 59 mm	W (↔) 56 mm (3 TE) L (↕) 100 mm H (↑) 59 mm	W (↔) 56 mm (3 TE) L (↕) 100 mm H (↑) 59 mm

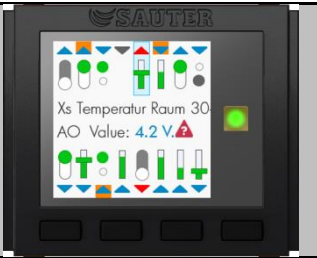
	
Reference number	EY6LO00F001
Name	modu600-LO
Description	Local Operation & Indication for IO-Module
Display	240 x 240-pixel colour display with backlight
Link	4 x spring pin strip
Fastening	Brackets
Compatibility	all modu6**-IO
Dimensions	W (↔) 56 mm (3 TE) L (↕) 45 mm H (↓) 19 mm

		Input								Output			
		Binary	CI	0-10 V	0-20 mA	Ni1000	Pt1000	R < 2,5 kW	Potentiometer	OC	Relay	0-10 V	0-20 mA
modu630-IO	16 x DI/CI	X	X										
modu631-IO	8 x UI + 8 x DI/CI	X	X	X		X	X						
modu650-IO	6 x DO_Relay										X		
modu670-IO	8 x DO_OC/DI/ CI + 8 x DI/CI	X	X							X			
modu671-IO	8 x AO + 8 x DI/CI	X	X									X	
modu672-IO	4 x AO + 4 x DO(OC) + 4 x UI	X	X	X	X	X	X	X	X	X		X	X

Table 1 Compilation of signals available on each I/O module.

3.3.2 modu630-IO 16 x DI/CI inputs I/O module (EY6IO30F001)

Reference number EY6IO30F001
 Printed name modu630-IO



Technical data

Power supply	Over the internal bus
Link between modules	7 side springs, gold coated, both sides
Connections	4 x 8 position pluggable PCB connectors with push-in spring connection
Compatibility	modu6**-AS modu6**-LC modu6**-IO modu6**-CM (right of)
Inputs	16 DI/CI digital inputs Max 30V _{DC} , 24V _{ac}
Outputs	None
LOI Link	4 contact plots on PCB, gold coated

LED	<ul style="list-style-type: none"> ● Power off ● Operational ● Not configured ● Communication error ● Start-up mode ● Configuration error ● LED test
Accessories	modu600-LO Local Operation & Indication for IO-Module

Description

The **modu630-IO** module is a high-density, cost-effective input module with 16 inputs (DI/CI) for digital and counter signals. The digital signals can be steady or pulse signals from counters going up to 50 Hz.

The bicolour LED indicates the module's operating state.

The **modu600-LO** local operation and indication module can be clipped on top of the module to visualise and operate (override) the values of the different output channels.

3.3.3 modu631-IO 8 x UI(DI/CI/AI) + 8 x DI/CI I/O module (EY6IO31F001)

Reference number EY6IO31F001
Printed name modu631-IO



Technical data

Power supply	Over the internal bus
Link between modules	7 side springs, gold coated, both sides
Connections	4 x 8 position pluggable PCB connectors with push-in spring connection
Compatibility	modu6**-AS modu6**-LC modu6**-IO modu6**-CM
Inputs	8 UI(DI/CI/AI) universal inputs 8 DI/CI digital inputs

Outputs	None
LOI Link	4 contact plots on PCB, gold coated
LED	<ul style="list-style-type: none"> ● Power off ● Operational ● Not configured ● Communication error ● Start-up mode ● Configuration error ● LED test
Accessories	modu600-LO Local Operation & Indication for IO-Module

Description

The **modu631-IO** module provides 8 universal inputs (UI(DI/CI/AI)) for both digital and analogue signals and a further 8 digital inputs (DI/CI) for digital signals.

The digital signals can be steady or pulse signals from counters going up to 50 Hz.

The analogue signals can be either voltage up to 10VDC and resistors such as Ni1000, Pt1000, or resistors up to 2.5 kΩ.

The bicolour LED indicates the module's operating state.

The **modu600-LO** local operation and indication module can be clipped on top of the module to visualise and operate (override) the values of the different output channels.

3.3.4 modu650-IO 6 x relay (2A) outputs I/O module (EY6IO50F001)

Reference number EY6IO50F001
 Printed name modu650-IO



Technical data

Power supply	Over the internal bus
Link between modules	7 side springs, gold coated, both sides
Connections	6 x 2 position pluggable PCB connectors with push-in spring connection
Compatibility	modu6**-AS modu6**-LC modu6**-IO modu6**-CM
Inputs	None
Outputs	6 x relay output (2A, 230Vac)
LOI Link	4 contact plots on PCB, gold coated

LED	<ul style="list-style-type: none"> ● Power off ● Operational ● Not configured ●● Communication error ● Start-up mode ●● Configuration error ●● LED test
Accessories	modu600-LO Local Operation & Indication for IO-Module

Description

The **modu650-IO** is an output module with 6 relays for up to 2A current and up to 50 Hz switching frequency.

The bicolour LED indicates the module's operating state.

The **modu600-LO** local operation and indication module can be clipped on top of the module to visualise and operate (override) the values of the different output channels.

3.3.5 modu670-IO 8 x DI/CI/DO(OC) + 8 x DI/CI I/O module (EY6IO70F001)

Reference number EY6IO70F001
Printed name modu670-IO



Technical data

Power supply	Over the internal bus
Link between modules	7 side springs, gold coated, both sides
Connections	4 x 8 position pluggable PCB connectors with push-in spring connection
Compatibility	modu6**-AS modu6**-LC modu6**-IO modu6**-CM
Inputs	8 x DI/CI/DO(OC) digital inputs/outputs 8 DI/CI digital inputs

Outputs	See above
LOI Link	4 contact plots on PCB, gold coated
LED	<ul style="list-style-type: none"> ● Power off ● Operational ● Not configured ● Communication error ● Start-up mode ● Configuration error ● LED test
Accessories	modu600-LO Local Operation & Indication for IO-Module

Description

The **modu670-IO** module provides 16 digital inputs for digital and counter signals. The digital signals can be steady or pulse signals from counters going up to 50 Hz. 8 of the inputs can also be used as digital outputs when wired in Open Collector mode (DO(OC)).

The bicolour LED indicates the module's operating state.

The **modu600-LO** local operation and indication module can be clipped on top of the module to visualise and operate (override) the values of the different output channels.

3.3.6 modu671-IO 8 x AO + 8 x DI/CI IO-Module (EY6IO71F001)

Reference number EY6IO71F001
 Printed name modu671-IO



Technical data

Power supply	Over the internal bus
Link between modules	7 side springs, gold coated, both sides
Connections	4 x 8 position pluggable PCB connectors with push-in spring connection
Compatibility	modu6**-AS modu6**-LC modu6**-IO modu6**-CM
Inputs	8 DI/CI digital inputs
Outputs	8 x AO analogue outputs

LOI Link	4 contact plots on PCB, gold coated
LED	<ul style="list-style-type: none"> ● Power off ● Operational ● Not configured ● Communication error ● Start-up mode ● Configuration error ● LED test
Accessories	modu600-LO Local Operation & Indication for IO-Module

Description

The **modu671-IO** provides up to 8 analogue outputs (AO) for both voltages up to 10V. An additional 8 digital inputs (DI/CI) are also available. The digital signals can be steady or pulse signals from counters going up to 50 Hz.

The bicolour LED indicates the module's operating state.

The **modu600-LO** local operation and indication module can be clipped on top of the module to visualise and operate (override) the values of the different output channels.

3.3.7 modu672-IO 4xAO, 4xDO(OC), 4xUI(DI/CI/AI) IO-Module (EY6IO72F001)

Reference number EY6IO72F001
Printed name modu672-IO



Technical data

Power supply	Over the internal bus
Link between modules	7 side springs, gold coated, both sides
Connections	4 x 8 position pluggable PCB connectors with push-in spring connection
Compatibility	modu6**-AS modu6**-LC modu6**-IO modu6**-CM
Inputs	4 x UI universal inputs
Outputs	4 x AO analogue outputs 4xDO(OC) digital outputs
LOI Link	4 contact plots on PCB, gold coated

LED	<ul style="list-style-type: none"> ● Power off ● Operational ● Not configured ●● Communication error ● Start-up mode ●● Configuration error ●● LED test
Accessories	modu600-LO Local Operation & Indication for IO-Module

Description

The **modu672-IO** module provides the highest flexibility of all the I/O modules.

The universal inputs UI(DI/CI/AI) can handle either digital or analogue signals. The digital signals can be steady or pulse signals from counters going up to 50 Hz.

The analogue outputs AO can handle either current or voltage analogue signals. The digital outputs DO(OC) must be wired as an open collector.

The digital outputs DO(OC) must be wired as an open collector.

The range of supported signals is extended compared to **modu671-IO** and includes:

Universal input	Analog Output	Digital Output
0(2) –10 V	0(2) –10 V	
0(4) –20 mA	0(4) –20 mA	
Ni1000 (-50...185°C)		
Pt1000 (-50...185°C)		
R (200...2500 Ω)		
Pot (500...10k Ω)		
DI/CI		DO (OC)

For use of the Pot mode, the output Uref (+3.0 Vdc) is available on each UI.

The bicolour LED indicates the module's operating state.

The **modu600-LO** local operation and indication module can be clipped on top of the module to visualise and operate (override) the values of the different output channels.

3.3.8 modu600-LO, operating and indicating unit for I/O modules (EY6LO00F001)

Reference number EY6LO00F001
 Printed name modu600-LO



Technical data

Power supply	From the I/O module
Link to module	4 x spring pin strip
Compatibility	modu6**-IO
Display	RGB colour TFT LCD 5.7 inches 240 x 240 Pixel

Operation	4 buttons:
	↵ Escape
	- Reduce
	+ Increase
	✓ Confirm
LED	<ul style="list-style-type: none"> ● Power off ● Operational ● Not configured ●● Communication error ● Start-up mode ● Configuration error ●● LED test

Description

The **modu600-LO** is a local override and indication unit that can be plugged on top of the I/O modules of the modu6**-IO family. The unit includes a 240x240 pixel colour LCD to display the current values and statuses of the signals on the I/O module and allows the local overriding of the output signals. The user interface provides an overview of all signals and the user can select a single signal for detailed information. The user interface also displays the signal labels, previously defined with the engineering tool and downloaded as part of the project through the station. With the four buttons on the unit, the user can navigate through the pages by choosing and selecting the items.

The unit can be configured via the engineering tool with timeouts to return to the overview and dim the backlight.

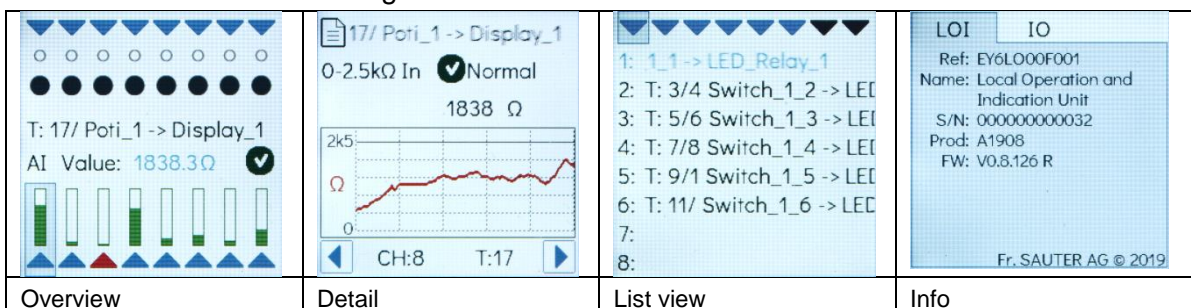

Figure 2 Graphical user interface



Symbols

Input / Output indicator		Grey: not configured with the engineering tool Green: configured and operational Red: Configured but an alarm is active
Next/Previous channel		
Digital output		Upper position: On / High / 1 Lower position: OFF / Low / 0
Digital input		Upper position, green: On / High / 1 Lower position, grey: OFF / Low / 0
Analogue output		Upper position: highest value Lower position: lowest value
Analogue input		Upper position: highest value Lower position: lowest value
Signal name		As defined by the engineering tool
Normal		No acknowledgement / not acknowledged
Overridden		By LOI / by App
Out of operation		
Fault		No acking/Not acked/acked
Alarm (Offnormal)		No acking/Not acked/acked

3.4 modulo 6 Communication Modules

modulo 6 communication modules provide extended integration capabilities with the support of fieldbus protocols relevant to building automation. Communication modules must be connected directly to the controller, without any other module type (LC, IO) in between.

3.4.1 Overview

		
Reference number	EY6CM20F011	EY6CM30F031
Name	modu620-CM	modu630-CM
Description	Modbus-RTU (RS-485) Communication Module	MBus Communication Module
Connections	Pluggable, 5 twin position, push-in spring connector	Pluggable, 5 twin position, push-in spring connector
Protocol	Modbus RTU/ASCII	MBus
Interface	RS-485	MBus, RS232
Use	Modbus master Up to 31 UL Up to 247 addresses Up to 600 values (DP)	MBus master Up to 80 UL Up to 256 addresses Up to 600 (DP)
Dimensions	W (↔) 56 mm (3 TE) L (↕) 97 mm H (↑) 59 mm	W (↔) 56 mm (3 TE) L (↕) 97 mm H (↑) 59 mm

3.4.2 modu620-CM Modbus-RTU (RS-485) Communication Module (EY6CM20F011)

Reference number EY6CM20F011

Printed name modu620-CM



Technical data

Power supply	Over the internal bus
Link between modules	9 side springs, gold coated, both sides
Connections	Pluggable, 5 twin position, push-in spring connector
Compatibility	modu6**-AS modu612-LC modu6**-CM modu6**-IO ¹¹ modu60*-LC ¹²
Interface	1 Unit Load (UL) Galv. Isolation up to 300 V Integrated RS-485 network resistors (LT, PU, PD) software configurable 600 - 115200 bit/s Parity, stop bit, Rx/Tx bus timing
Wiring	Twisted, 4-/3-wire (D+, D-, C), shielded, up to 1,000 m
Protocol	Modbus/RTU or Modbus/ASCII, master as of v1.02, 2-wire (2W)
Use	Modbus master Integration of devices, subsystems Up to 31 RS-485 Slave units (UL) Up to 247 Device-addresses Up to 600 values (DP)

LED	<ul style="list-style-type: none"> ● Power off ● OK (but no traffic, no configuration) ● OK (traffic, all DP configured correctly) ● Bus error (at least one DP cannot communicate) ● Communication error
Accessories	–

¹¹ I/O modules must be set after the CM modules

¹² LC modules must be set after the CM modules

Description

modu620-CM provides the modulo 6 controllers with an RS-485 interface, which enables direct integration of Modbus devices (slaves) into BACnet/IP automation. The Modbus devices (e.g. operating units, counters, actuators or sensors) are configured in CASE Engine. The Modbus data points are mapped to BACnet input, output or value objects in CASE Engine. This means that Modbus data points, just like all other objects, can be used in the free programming of control and logic functions with CASE Engine.

The RS-485 network for fieldbus protocols must be implemented according to ANSI/TIA/EIA-485-A (half-duplex (D+/D-), galvanically isolated (COM reference), network resistors with pull-up (PU), pull-down (PD), line end resistors (LT: line termination)). With the Modbus module configuration, the resistors can be switched on or off via software. It is recommended to use a shielded twisted cable (1x2+1 wire, 2x2 wire) specifically for RS-485. JYST-Y cables with a cable impedance of 100 - 120 Ohm and sufficient diameter (0.8 mm² resp. 0.5 mm²) are also possible. The cable must be routed in a line topology and the shield must be connected to the earth in one place. The maximum cable length is 1000 m. The baud rate can be 600 up to 115.2 k bit/s. The Modbus module as the master also supports different communication parameters simultaneously (e.g. baud rates, device timings, Modbus mode (RTU/ASCII)).

Before commissioning, the Modbus devices and their supported functions must be checked and the devices addressed and configured. The supported functions are then parameterised in CASE Engine. The Modbus master function is configured in the module configuration, the individual specific device parameters in the device table, and the Modbus function (function code) in the BACnet I/O/V blocks.

For easy commissioning and maintenance, a virtual serial port can be activated on the station so that conventional Modbus master tools can set up a direct connection to the Modbus devices via IP/Ethernet without additional RS-485 converters.

3.4.3 modu630-CM M-Bus communication module (EY6CM30F031)

Reference number EY6CM30F031
 Printed name modu630-CM



Technical data

Power supply	Over the internal bus
Link between modules	9 side springs, gold coated, both sides
Connections	Pluggable, 5 twin position, push-in spring connector
Compatibility	modu6**-AS modu612-LC modu6**-CM modu6**-IO ¹³ modu60*-LC ¹⁴
Interface	MBus & RS232
Wiring	MBus (D+, D-, C) RS232 (Tx, Rx, C)
Protocol	MBus
Use	MBus master Up to 80 UL Up to 256 Device-addresses Up to 600 values (DP)
LED	<ul style="list-style-type: none"> ● Power off ● OK (but no SMI traffic) ●● OK (active bus traffic) ● Bus error (short-circuit or power supply issue) ●● Communication error ● Start-up mode
Accessories	Fieldbus power supply

¹³ I/O modules must be set after the CM modules

¹⁴ LC modules must be set after the CM modules

Description

modu630-CM provides the modulo 6 automation stations with M-Bus and RS-232 interfaces for M-Bus (Meter-Bus). The M-Bus interface (EN 13757-2) with the M-Bus master application (EN 13757-3) enables the direct integration of up to 80 M-Bus unit loads (heat, electrical, water meters). The physical M-Bus layer and RS-232 interface are electrically isolated from the automation station. Two microprocessors (APP, PHY) fulfil a modern M-Bus implementation according to EN 13757. With the additional RS-232 interface, further M-Bus meters can be integrated via an external RS-232 M-Bus level converter. The M-Bus master application on the communication module transfers the meter values suitably to the BACnet/IP automation and can be used with CASE Suite (from V4.1) and modulo 6 automation stations.

The M-Bus meters are configured in CASE Engine. The M-Bus data points are mapped to the CASE Engine input and value objects (AI, BI, PIV(I)). An output object can be used for the M-Bus readout trigger of a meter. This means that the meter values, just like all other objects, can be used in the free programming of control and logic functions with CASE Engine (e.g. load shedding in the event of excessive energy consumption, energy monitoring with trend log). The ecos communicates with all meters. The M-Bus network is thus a local field bus within building automation with BACnet.

The M-Bus network (M+/M-) can be linear, tree-shaped or star-shaped with installation cables such as JY(ST)Y 4 × 0.5 mm² (recommended with double core guide) or, in the case of more extensive networks, with firmer cables such as LiYY 2 × 1.5 mm². Depending on cable cross-section, baud rate, number of M-Bus unit loads and topology (number of segments), standard M-Bus networks up to 1000 or 4000 metres are possible. The table shows typical M-Bus network configurations:

Configuration	Cable	Max. Segment length (m)	Number	Max. M-Bus (UL)	Max. Baud rate
Mini	J-Y(ST)Y 4 × 0.5 mm ²	350	1	80	9600
Building, small	J-Y(ST)Y 4 × 0.5 mm ²	350	3	80	9600
Building, large	J-Y(ST)Y 4 × 0,5 mm ²	350	10	80	9600
Several buildings	J-Y(ST)Y 4 × 0,5 mm ²	1000	4	80	9600
Wide range	LiYY J-Y(ST) 2 × 1.5 mm ²	4000	1	48	2400

Table 2 Examples of maximum load by type of plant.

A maximum of 4 modu630-CM modules with the maximum load on the MBus (80 UL) can be attached to an AS. The installation of a modu601-LC after the CM modules is recommended.

The M-Bus module as master supports up to 4 different communication parameters (fixed baud rates) simultaneously. The M-Bus module supports M-Bus devices with primary or secondary addressing.

Before commissioning, the M-Bus devices and their supported functions must be clarified and configured. CASE Engine is used to parameterise the functions (module configuration, device table, BACnet I/O/V modules) for the devices and load them on the automation station. For easy commissioning and maintenance, a virtual serial port can be activated on the automation station, so that M-Bus master tools (addressing/configuration) or the ecosReader tool (bus analysis) can connect directly to the M-Bus network via IP/Ethernet without an additional M-Bus level converter.

3.5 modulo 6 Web Operation and Services

3.5.1 moduWeb Unity

moduWeb Unity is the embedded web server present in all the IP-based devices: **modu680-AS**, **modu660-AS** and **modu612-LC**. The web server with responsive design is based on HTML5, CSS3 and JS technologies and can be used with mobile devices as well as on desktop PCs. Content is changed and updated more efficiently. Instead of reloading complete pages from the server, just the updated content is exchanged between the server and the clients. Access to the building automation system both locally and over the Internet becomes child's play.

moduWeb Unity includes the main functionalities of a BMS. Data points can be easily displayed and modified both via lists and dynamic pictures with 2D or 3D representation. A dedicated alarm management view allows users to easily identify alarms and acknowledge them after they have been notified via email or on their mobile phone. Historical data is logged constantly and can be displayed individually or in a combined form. User actions are also recorded in an audit trail log.

moduWeb Unity supports TLS for encrypted communication for https, ftp, and other communication protocols used to transfer information. The web server includes account management, providing the necessary identification and authentication credentials and restricted user access, which can be provided on a need-to-know-only basis.

The functionality of **moduWeb Unity** can be upgraded to extend the reach of the visualisation, from the local station to other stations in the network. Furthermore, extended features can be enabled. A demonstration mode can be enabled for testing and sales support purposes.

Overview

moduWeb Unity comes in 3 major variants:

- moduWeb Unity System Management
- moduWeb Unity Plant Visualisation
- moduWeb Unity Network Visualisation

Depending on the station model, the available variant changes:

	modu612-LC	modu660-AS	modu680-AS
Upgrade		Plant visualisation	Network Visualisation
Standard	System Management	System Management	Plant Visualisation System Management

Table 3 The table shows which is the standard, default variant on each device, and which upgrades are possible.

The System Management is supported by all IP-capable devices, while the Plant Visualisation part is enabled by default in **modu680-AS**.

The Plant Visualization allows you to dynamise up to 500 BACnet objects. With licenses Y6WS60F009 or Y6WS80F009, this limit is removed.

The RESTful interface can be activated with Y6WS80F008 and Y6WS60F008 licenses.

The Windows® application for touch screens already supported by SAUTER Vision Center can also be used with mWU with licences Y6WS80F100 or Y6WS60F100. Two terminals can be connected to one station.

moduWeb Unity can generate reports and send them periodically to email recipients or an FTP server. The content of the reports is defined in a template and is based on the stored historical data and can be sent as a plain text csv. The generation of a report using a given template is scheduled and distributed according to a customisable list of email recipients or an FTP server.

References for enabling licenses are:

Reference number	Description
Y6WS80F031	Activation code of Network extension on modu680-AS
Y6WS80F009	Activation code to unlock visualisation limit of 500 DP
Y6WS80F008	Activation code for the RESTful API
Y6WS80F007	Activation code for the report generation on modu680-AS
Y6WS80F100	Activation code for supporting Touchpanels (2) on modu680-AS
Y6WS60F021	Activation code of Visualization on modu660-AS
Y6WS60F009	Activation code to unlock visualisation limit of 500 DP
Y6WS60F008	Activation code for the RESTful API
Y6WS60F007	Activation code for the report generation on modu660-AS
Y6WS60F100	Activation code for supporting Touchpanels (2) on modu660-AS

Table 4 **References for upgrading the web server**

Each variant provides additional functionality with it. But the structure remains the same across all variants, supporting users' intuitive behaviour and thus avoiding the need for any additional training. The navigation in the web server is extended with each variant so that all functions remain in the same location.

The following chapters describe the functionality within each version.

System management

The system management features of **moduWeb Unity** are included in all devices with an IP Network connection by default. Under System Management, the device commissioning is made possible directly via the web user interface, without any additional tooling. The attached modules can also be detected and commissioned. No project is needed at this stage. Also important is the possibility to upgrade the web server functionality with license activation, as long as the device allows it.

The following list provides an overview of features under the System management menu:

- User Management
Management of user accounts, user role, access rights and notification methods (mail, phone)

- **Project Management**
Includes File manager for removable storage media to backup and restore project content as well as login restrictions
- **Network and security settings**
All related to IP settings, servers, proxies and certificates
- **General device settings**
Other device settings like time and date.
- **About**
Software, licensing and API information

moduWeb Unity Visualisation

With **moduWeb Unity** visualization functions, the application can be represented in 2D or 3D images. Die umfangreichen grafischen Möglichkeiten ermöglichen die Realisierung dynamischer Bilder, die den effektiven Status darstellen. Users can interact via this user interface and change values like set-points or switching lights on or off. The information can be structured to ease reading and obtain quick access to the relevant information. Changes made by any user are logged in an audit trail.

Dedicated views and optimised wizards allow the most important functions to be easily managed. The system and application alarms have dedicated views, for the current alarms and the alarms' history. The user can select the chronological or structured view. The current alarm status and messages are displayed on the list and alarms can be acknowledged. Schedules and Calendars also have dedicated views for quick identification of the operating status.

The visualisation mode is standard in **modu680-AS** and can be activated on **modu660-AS**, where it is also available in demonstration mode for a limited time.

- **Alarm management**
Displays current alarms and alarms history. Acknowledges alarms and exports alarm list
- **Alarm notification**
Sends alarms to selected users' email or phone account
- **Plant visualisation and dynamization**
Structured navigation across dynamic pictures of the plant. Visualisation and manipulation of object and value lists
- **Charts**
Graphical representation of values history
- **Audit trail**
List of user operations. Export list
- **Advanced functions**
Configuring Schedules & Calendars, Trend Logs or simple Commands
- **Project settings**

moduWeb Unity Network

moduWeb Unity can be extended on **modu680-AS** to include other modulo 6 and BACnet devices in the network. Thus, a single point of access is provided to the

moduWeb Unity visualisation, alarming and notification functionality. Additionally, this extension also allows a centralised management of the modulo 6 devices which also supports **moduWeb Unity**. It is possible to share and manage user credentials and rights for other devices.

- Common alarm list
Alarm consolidation in one list for all registered devices
- Common visualisation
Visualisation solution including local and remote devices
- Remote device management
Network scan and device embedding

3.6 modulo 6 - Data integrity

3.6.1 Overview

The IEC 62443 standard is aimed at IT security for networks and systems ("Industrial communication networks - Network and system security"). The IEC 62443 standard distinguishes 7 categories of requirements for automation systems. One of them is data integrity. This means that data is not unintentionally or intentionally created, modified or deleted. As part of its "Security by Design" strategy, SAUTER has developed and patented a solution which verifies the data integrity of the configuration from the automation stations and resets it if necessary.

SAUTER Blockchain-Ring

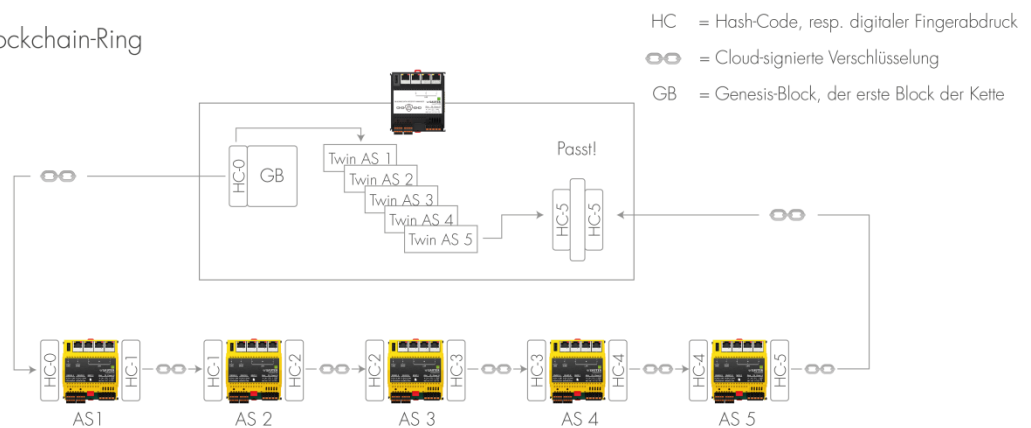

HC = Hash-Code, resp. digitaler Fingerabdruck

 = Cloud-signierte Verschlüsselung

GB = Genesis-Block, der erste Block der Kette

Zu sicherndes Gebäudeautomationsnetzwerk mit Automationsstationen der SAUTER Gerätefamilie modulo 6

modu615-BM Building Data Integrity Manager & Webserver (EY6BM15F011)

Reference number EY6AS80F021
Printed name modu680-AS

Technical data

Power supply	24 V _{DC} +/- 10%
CPU	ARM™ Cortex™ A8
Frequency	1 GHz
RAM (DDR3)	512 MB
Flash (NAND)	512 MB
OS	Linux-based v. 4.9 or newer
Ethernet	10/100 3 x downlink (switched)
Connections	Printed circuit board connector for plug-in spring connectors
Protocols	SMTP, HTTPS, SMPP MQTT (Broker, Client)
Web server	Yes
WS features	Setup of the Blockchain solution Visualisation of the chain, status of the stations and log

	of all events User Management
On-board security	Patented block chain based data integrity solution TLS encryption 2-factor authentication
LED	<ul style="list-style-type: none"> ● Power off ● Operational ●● CASE Sun identification ● No Plan loaded ●● In configuration, restart/download ongoing ●●● Internal device error ● Start-up mode ● Low battery ●● LED test

Description

modu615-BM is the local, embedded solution for setting up and operating the SAUTER Building Data Integrity solution. Based on the same hardware platform as the modulo 6 automation stations, the device is used both to set up the patented blockchain solution and to monitor the status of the various links (stations) in the chain. As a manager, the device controls the periodic execution of the integrity check and, in the event of an integrity breach, reports the event via SMTP (e-mail) and MQTT.

The integrity check is based on a comparison between a digital twin (stored in the BDI-Manager) of the project of the automation station and the current status of the same automation station, for all links (automation stations) in the blockchain. An automation station from which the data no longer matches its digital twin is immediately isolated (quarantined) and, if desired, automatically reset according to the digital twin.

The embedded web server allows managing the blockchain. Access to the web server is secured with 2-factor authentication and TLS encryption. The web server supports user management so that not only the automatic events but also the user events are recorded in the log. When configuring the blockchain, a scan of the local network is done to identify all compatible automation stations. The content of the selected ones is then read and a digital twin is created. Finally, the chain is built and the integrity monitoring started.

Maximum configuration

- Up to 100 links in the blockchain:
- Supported links:
 - modu680-AS
 - modu660-AS
 - modu612-LC
 - ecos504/505 (planned)





4 Room automation

4.1 ecos 5 room automation





The ecos 5 room Automation Stations are a range of stations in the EY-modulo 5 family specially designed for the requirements of comprehensive room automation.

They use the same technology as the SAUTER modu 5 Automation Stations and are thus also native BACnet stations with communication via Ethernet with BACnet/IP. They can be completely homogeneously integrated into the EY-modulo 5 and modulo 6 overall system.

4.1.1 ecos500, ecos502, ecos504/505 Room Automation Station

				
Type	EY-RC500F001/F002	EY-RC502F001	EY-RC504F0**	EY-RC505F0**
Product name	ecos500	ecos502	ecos504	ecos505
Function	4 room segments	2 room segments	8 room segments	8 room segments
Power supply	230 V~	230 V~	24 V=/~	24 V=/~
SLC/RS-485 interfaces	2	1	2	2
Room operating units	1 x 4	1 x 4	2 x 4	2 x 4
I/O extension modules	1 x 16	–	2 x 8	2 x 8
Communication interfaces	–	–	1	3
Communication protocols	SLC	RU/SLC	SLC, KNX, DALI, SMI, MBus, Modbus	SLC, KNX, DALI, SMI, MBus, Modbus
Terminal type	Screw terminals (F001) Push-in terminals (F002)	Screw terminals	Push-in terminals	Push-in terminals
Inputs/outputs				
Universal inputs	8	8	–	–
Digital inputs	4	4	–	–
Normally-open relay contacts	16	16	–	–
Changeover relay contacts	–	2	–	–
Triac	8	8	–	–
Analogue inputs	4	4	–	–
Analogue outputs	4	4	–	–
BACnet profile	B-BC	B-BC	B-BC	B-BC
Objects				
Data points	256	256	600	600
Loop	32	32	32	32

Room automation

				
Calendar	8	8	16	16
Schedule	32	32	32	32
Trend Log	16	16	256	256

Type	KNX	DALI	SMI	Modbus	MBus
EY-RC504F001	–	–	–	–	–
EY-RC504F011	•	–	–	–	–
EY-RC404F021	–	•	–	–	–
EY-RC504F041	–	–	•	–	–
EY-RC504F0C1	–	–	–	•	–
EY-RC504F0D1	–	–	–	–	•
EY-RC505F031	•	•	–	–	–
EY-RC505F051	–	–	•	–	–
EY-RC505F061	•	–	•	–	–
EY-RC505F071	•	•	•	–	–
EY-RC505F081	–	••	–	–	–
EY-RC505F091	–	•	••	–	–
EY-RC505F0A1	•	••	–	–	–
EY-RC505F0B1	–	–	••	–	–
EY-RC505F0E1	–	–	–	•	•
EY-RC505F0F1	–	•	–	•	–

Table 5 Available references and related interfaces. • 1 Interface, •• 2 Interfaces.

Type	Additional function
EY-RC504F101	moduWeb & Meteomodul
EY-RC504F202	Cloud Connector (BACnet-MQTT Gateway)

Table 6 Functions additionally activated in EY-RC504

The **ecos 5 room Automation Stations** are designed for temperature regulation and for controlling lights, blinds etc. in individually regulated rooms.

The ecos500 and ecos502 provide all inputs and outputs for room automation compactly and directly on the device.

The **ecos502** is designed for the control of **2 rooms or 2 segments** (i.e. the I/O mix of the ecos502 is adapted for 2 rooms or 2 segments); the **ecos500** is designed for **4 rooms or 4 segments**.

On the ecos500 and ecos502 stations, 8 of the 12 inputs are **universal inputs** (UI) that can be parameterised freely as temperature, voltage or current measurement inputs or binary inputs. This offers the option of **optimum use of the I/O mix** of the station.

On the ecos500, the I/O mix can also be expanded for more complex applications using decentrally mountable ecoLink input/output modules. The ecoLink modules are

connected to the ecos 5 in bus form (RS-485 interface) and can be located up to 500 m away from the station (See section 4.2: Remote ecoLink I/O modules)

ecos504 and **ecos505** are modular stations and have neither inputs nor outputs. The inputs/outputs are modular with the remote ecoLink I/O modules and the integrated communication interfaces for DALI, KNX, SMI, MBus and Modbus. ecos504 and ecos505 are designed for controlling up to 8 rooms or room segments.

In addition to the control and regulation functions, comprehensive **time and calendar functions** are also available. Up to 32 BACnet time programme objects (Schedule) and 8 BACnet Calendar objects (Calendar) can be created in the Automation Station.

4 or 2 x 4 connectable room operating units of type ecoUnit 3 (EYRU3F***) or ecoUnit 1 (EY-RU1F***) are used for room-temperature measurement and allow individual adjustment of the room climate to the user's requirements (see section ecoUnit room operating units)

Powerful function modules in the ecos 5 stations enable **energy-optimised room control**. The following also aid the optimisation of the **energy consumption** of the controlled rooms: presence function, window contact monitoring, demand-controlled switching of fan speeds, control of lighting and window blinds, and time-dependent setpoint specification.

The complete **user program** and the different parameterisations (BACnet objects, etc.) are created using **CASE Suite**. Up to 256 or 600 BACnet data points incl. hardware inputs and outputs can be used. For programming/parameterisation in CASE Suite, comprehensive **regulating libraries** are available.

The user program and the changed data (e.g. changed by the BACnet client) are stored persistently in the **flash memory**. An insertable **lithium button-cell battery** ensures that the RTC for time programmes (Scheduler/Calendar) and data such as meters, e.g. adaptive control algorithms, are retained in the memory (SRAM), even if there is a power failure.

ecos 5 are compact units intended for wall mounting or for DIN 43880 series installation on a 35 mm DIN rail.

For BACnet communication, two RJ45 network connections with integrated **Ethernet switch** functionality are available. This allows the ecos 5 to be connected in series (daisy chain wiring).

As an accessory for the ecos500 and ecos502 stations, there is a Snap-On 2-part **wiring box** that allows space for the necessary connections of the neutral and earth wires and thus allows cost-effective installation of the ecos 5 without additional wiring boxes.

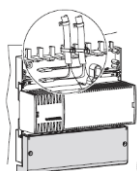

Room automation

An ecos504/505 with the I/O modules is usually designed in a room box as a series installation.

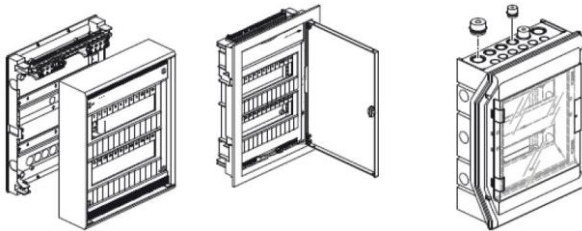

ecos504-IoT

The ecos504 with Cloud Connector (short: "ecos504-IoT"; EY-RC504F202) is a programmable BACnet server (B-BC) with integrated BACnet-MQTT gateway (BACnet client, MQTT client and optional MQTT broker). It provides the most important BACnet information of the Cloud via MQTT (MQTT Publisher) and receives information from the Cloud via MQTT (MQTT Subscriber). The MQTT Broker function is optionally available on the ecos for direct data exchange with other MQTT devices. Communication via MQTT is encrypted with TLS.

The ecos504-IoT is the gateway between the technical building automation network and a Cloud, i.e. a "BACnet edge controller". Detailed information from a Cloud application such as the AVS (Alexa Voice Service) in the Amazon AWS Cloud can control a BACnet device via ecos504-IoT in the GA network. Information from the BACnet network can be made available in the Cloud via ecos504-IoT.

The Cloud Connector includes the following additional features to the standard ecos504.

- MQTT Client (MQTT Publisher, MQTT Subscriber)
- MQTT protocol V3.1.1 encrypted via TLS
- Optionally connectible MQTT Broker (server)





4.1.2 ecoUnit room operating units

ecoUnits are the room operating units for the ecos 5 room Automation Stations. They are used to measure the room's temperature and, depending on the type, have different operating options and a display with information about the room's condition.



The range of room operating units comprises **three basic variants**:

- devices with **LED indicator** (ecoUnit310...316):

Room automation





				
Type	EY-RU310F001	EY-RU311F001	EY-RU314F001	EY-RU316F001
Name	ecoUnit310	ecoUnit311	ecoUnit314	ecoUnit316
Use	Temperature sensor	Temperature sensor and command	Temperature sensor Temperature, fan and Presence command	Temperature sensor Temperature, fan Presence, blinds or light command
Indicators/display	LED	LED	LED	LED
Button functions	–	Rotary knob	Rotary knob	Rotary knob
Fan speeds	–	–	Auto-0-1-2-3	Auto-0-1-2-3
Setpoint correction	–	Adjustable	Adjustable	Adjustable
Room occupancy	–	–	3 modes	3 modes
Fan	–	–	5 modes	5 modes
NTC sensor	✓	✓	✓	✓
Power supply	From ecos 5	From ecos 5	From ecos 5	From ecos 5

- devices with **digital display** (ecoUnit 355...358)

		
Type	EY-RU355F***	EY-SU358F***
Name	ecoUnit355	ecoUnit358
Use	Temperature sensor Temperature, fan, presence, blinds, light or ECO command (freely configurable).	light and/or blinds command with 2, 4 or 8 setpoints
Interface	SLC/RS-485	SLC/RS-485
Indicators/display	LCD	LCD
NTC sensor	Yes	–
Button functions	Configurable (5)	Configurable (2, 4 or 8)
Fan speeds	5 modes (Auto – 0 – 1 – 2 – 3)	–
Room occupancy	3 modes (out, in, reduced)	–
Date/time	Switchable	–
Air quality	3 modes (good, average, bad)	–
Symbols	Switchable (heat, cold, ECO, window, Dew, Lock, Logo)	–
Units	CO2, ppm, Lx, Pa, %, rH, l/S, m ³ /h	–
Setpoint correction	Adjustable	–

- devices with wireless communication (EnOcean standard) (ecoUnit110...146):

Room automation

				
Type	EY-RU110F100	EY-RU141F100	EY-RU144F100	EY-RU146F100
Name	ecoUnit110	ecoUnit141	ecoUnit144	ecoUnit146
Use	Temperature	Temperature	Temperature, fan Presence	Temperature, fan Presence/light
Indicators/display	–	LCD	LCD	LCD
Data transmission	Wireless (868 MHz)	Wireless (868 MHz)	Wireless (868 MHz)	Wireless (868 MHz)
Button functions	–	–	–	2 buttons
Fan speeds	–	–	Auto-0-1-2-3	Auto-0-1-2-3
Setpoint correction	–	Adjustable	Adjustable	Adjustable
Room occupancy	–	–	3 modes	3 modes
Fan	–	–	5 modes	5 modes
NTC sensor	✓	✓	✓	✓
Power supply	Solar cell	Solar cell	Solar cell	Solar cell

Within these 3 variants, the devices are ordered according to **functionality**:

- Temperature detection
- Additional setpoint correction
- Additional fan control, presence button
- additional light and/or window blind control

All ecoUnit room operating units have standardised fitting dimensions. **Installation** takes place in standardised fastening frames with a 55x55 mm section. These frames are available in many design variants, materials and colours for surface or recessed fitting from both SAUTER and third-party suppliers.

A **labelling film** behind the transparent front cover allows the room operating units to be adapted to local requirements.

Connection to the ecos 5 is via a serial connection (RS-485). On the **wireless** devices (ecoUnit110...146), communication is according to the **EnOcean standard**. Within the ecos 5, an EnOcean wireless gateway (ecoMod580) is used.

The ecoUnit room operating units are expandable with an additional **ecoUnit306** or **ecoUnit106 push-button unit**.

4.1.3 ecoUnit-Touch room operating units

The ecoUnit365 (EY-RU 365) touch room operating unit records the room temperature. It is used for the local operation of up to 12 setpoints for temperature control, fan control, lighting and sunshade for one or more rooms. The “virtual” buttons in the touch display

are defined as function tiles. The functions defined on six pages, with up to six tiles per page, can be operated intuitively using the gesture control familiar from smartphone usage. The touch room operating unit with a Bluetooth interface (EY-RU365F0*2) enables the user to control the functions of the ecoUnit365 using a smartphone and the “SAUTER room management” App (iOS, Android) via Bluetooth 4.0 LE.

	
Type	EY-RU365F00*
Name	ecoUnit365
Use	Temperature
Function	Temperature sensor, 12 setpoints with 4 functions (temperature, lights, blinds and fans)
Interface	SLC/RS-485
Indicators/display	3.5" TFT colour display
Temperature sensor	Yes
Button functions	12 on 6 x 6 tiles
Fan speeds	Yes
Setpoint correction	Digitally adjustable
Room occupancy	Yes



4.1.4 Remote ecoLink I/O modules

The decentrally mountable ecoLink input/output modules are used to expand the I/O mix of the ecos 5, and to reduce the wiring costs. The modules are connected to the ecos 5 in bus form (RS-485 interface) and can be located up to 500 m away from the station.

11 different types are available for selection:



- 5 models with 24 V~/~ power supply:

(For applications such as fan coil units, chilled and heated ceilings and activation of valve actuators etc.):

			
	EY-EM510F001	EY-EM511F001	EY-EM512F001
Product name	ecoLink510	ecoLink511	ecoLink512
Power supply	24 V~	24 V~	24 V~
Inputs/outputs			
Universal inputs	—	—	—





Room automation

0-10 V/digital inputs	4	4	4
Ni1000/Pt1000	2	2	—
DIM-10 V outputs	—	—	—
Normally-open relay contacts	3	—	—
Changeover relay contacts	—	—	—
Triac	3	3	2
Analogue outputs	3	3	3





		
	EY-EM514F001	EY-EM515F001
Product name	ecoLink514	ecoLink515
Power supply	24 V=/~	24 V=/~
Inputs/outputs		
Universal inputs	4	4
0-10 V/digital inputs	—	—
Ni1000/Pt1000	—	—
DIM-10 V outputs	—	—
Normally-open relay contacts	4	—
Changeover relay contacts	—	—
Triac 24 V=	—	—
MOS-FET 24 V=/~	6	6
Analogue outputs	4	4



Supply is via an external power supply unit.

6 models with 230 V power supply: (Mostly used to control lights and blinds):

				
	EY-EM520F001	EY-EM521F001	EY-EM522F001	EY-EM523F001
Product name	ecoLink520	ecoLink521	ecoLink522	ecoLink523
Power supply	230 V~	230 V~	230 V~	230 V~
Inputs/outputs				
Universal inputs	—	—	4	4
0-10 V/digital inputs	4	4	—	—
Ni1000/Pt1000	—	—	—	—
Digital/meter inputs	—	—	—	—
DIM-10 V outputs	2	2	4	4
Normally-open relay contacts	4	2	4	—
Changeover relay contacts	—	—	—	—

Room automation

				
Triac 24 V=	—	—	—	—
Analogue outputs	—	—	4	4

		
	EY-EM526F001	EY-EM527F001
Product name	ecoLink526	ecoLink527
Power supply	230 V~	230 V~
Inputs/outputs		
Universal inputs	—	4
0-10 V/digital inputs	4	—
Ni1000/Pt1000	—	—
Digital/meter inputs	—	4
DIM-10 V outputs	2	—
Normally-open relay contacts	4	4
Changeover relay contacts	—	—
Triac 24 V=	—	—
Analogue outputs	—	—

Up to 16 modules (ecos500) or 2 x 8 modules (ecos504/505) can be connected to the sub-bus. In this way, the I/O mix can be adjusted optimally to the requirements.

Every module can be assigned to a segment, enabling flexible rooms to be set up. The inputs and outputs of a module can, however, also be parameterised and assigned individually with CASE (segment plant). This makes it possible to use the modules optimally for flexible room segments.

Building Management and Control

5 Building Management and Control

5.1 SAUTER Vision Center – central building management and visualisation

SAUTER Vision Center is a web-based building management solution in the HTML5 standard. It allows platform-independent operation on smartphones, tablets or desktop PCs without setting up inconvenient plug-ins. This means that personnel always have access to the new, individually configurable dashboards as a central information interface for system operation, energy consumption, associated alarms and key figures and lots more. Other detailed information such as alarm reports, interactive object lists, diagrams and reports can also be accessed directly.

Projects of all sizes

SAUTER Vision Center is suitable for both larger single buildings and entire real estate parks or decentralised premises. Typical areas of use are office complexes, business parks, college and industrial campuses, airports, railway stations, hospitals or internationally distributed branch networks. The modular concept allows the software to be extended precisely to meet the customer requirements of every installation.

SAUTER Vision Center sends alarms directly via e-mail or SMS to mobile phones according to the responsibilities assigned. With its many user-defined settings and dashboards that can be customised with drag & drop, SAUTER Vision Center guarantees maximum user convenience. This enables complete concentration on the monitoring and evaluation of the installations, as well as their optimum operation, and contributes to efficient, sustainable building and energy management.

Building, energy and maintenance management

The functionalities of SAUTER Vision Center go far beyond the usual tasks of a building management system, such as the visualisation, monitoring, logging and controlling of installations: With its energy management module, the solution supports system operators efficiently during energy and maintenance management. Users can map consumption values and KPIs on their charts and dashboards and check current values hourly if required. The different views are organised in building, energy or user-defined navigation structures and can be selected directly.

During service planning, the maintenance management also supports service tasks and creates task orders based on the building management system data that can be assigned and monitored by the service manager.

Communication protocols

With the certified BACnet client in SAUTER Vision Center and the OPC UA client, practically all devices and information sources in the building can be connected. The standardised protocols enable both SAUTER and non-SAUTER devices to be incorporated. Vision Center has an OPC UA / DA gateway for the integration of older OPC DA servers. SAUTER Vision Center additionally offers operation as an OPC UA server to enable all building management information to be integrated for other applications via an OPC UA client.

This range of integration options with many different protocols such as M-Bus, Modbus, LON and system-specific OPC servers, as well as BACnet, enables the highest level of flexibility for controlling various building parts and system generations using the building management software. This enables the plannable, successive migration of building parts and premises to the central SAUTER Vision Center building management.

Naturally, SAUTER Vision Center also supports connection via the SAUTER novaNet communication protocol, so that even older installations can benefit from the innovations of this state-of-the-art building management software.

SAUTER Vision Center also has a REST API for connecting applications that use building management information for their purposes. Thus, SAUTER Vision Center can be incorporated into the processes and application structures of companies as a central component.

Highlights:

For projects of all sizes:

SVC is suitable for buildings of all types – from single buildings to multi-site premises and big projects, and from administration buildings to research labs.

Easy to operate for all users:

With personalised views and navigations such as dashboards, lists etc., each user can put together the information relevant to their range of tasks and view all of it at the same time.

Scenario Manager for very simple operation:

The Scenario Manager enables scenarios to be defined and assigned with a few clicks in SVC, providing even more flexible system management.

Access regardless of location:

SVC provides information on all conventional end devices such as desktops, laptops, tablets, smartphones and smartwatches.

Centralised building, energy and maintenance management:

SVC has a modular structure and is freely scalable. The integration of specialised auxiliary modules enables it to be used for different tasks in the building.

Building Management and Control**Room management:**

SVC supports the segment concept of SAUTER room automation allowing room segment assignments to be immediately adjusted to the customer's needs via the building management without any engineering work. For example, the adjustment of office sizes when tenants change or particular controlling of rooms when empty for energy optimisation.

Precise insights for smart building management:

SVC creates user-specific evaluations for owners, managers and users and supports them in optimising building operations.

Security and compliance:

With special functions for traceability and gap-free data acquisition, SVC provides increased security for business-critical systems and processes.

Investment security thanks to standards and expandability:

SVC is BACnet-certified, also uses OPC UA and supports the connection of SAUTER novaNet for a heterogeneous system landscape. This is what we mean by successive extension and gentle migration for ultimate investment security.

5.2 SAUTER Engineering Suite

The SAUTER CASE Suite engineering software with various modules for SAUTER devices and software packages is optimised for use with SVC. In particular, CASE Vision can be used to engineer all SAUTER Vision Center projects and the visualisation libraries can be used to set them up efficiently and uniformly. In addition, Vision Center Studio offers a local engineering tool for direct installation on the SVC server to make small, quick changes or extensions online.

For an extended description of the engineering toolchain, read the chapter on the Integrated CASE Suite service.

6 System Integration

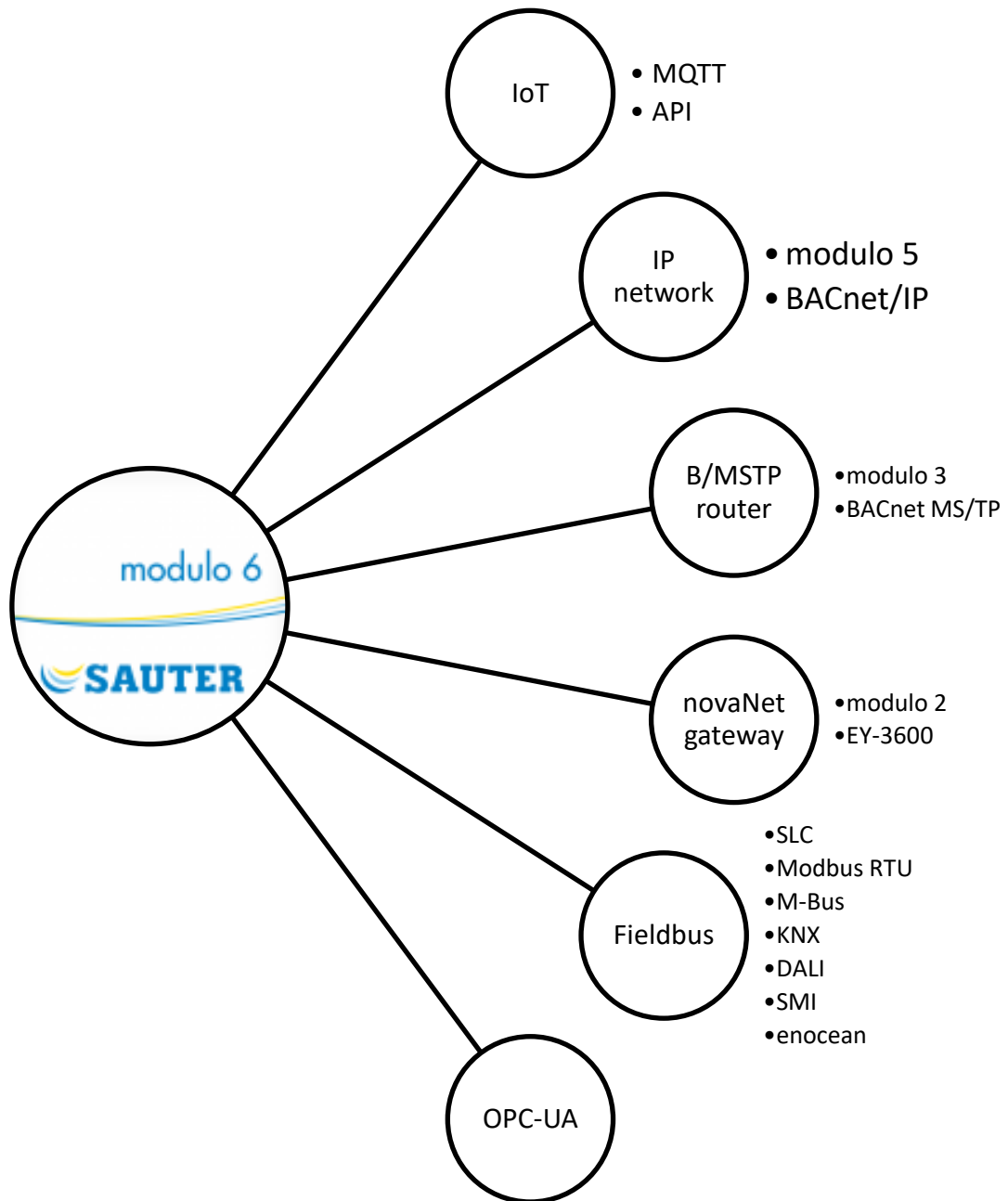

System Integration

6.1 Overview

Product family / generation / interface	Integration into modulo 6 solution
modulo 5	BACnet/IP
Third-party providers	BACnet/IP products or gateways to BACnet/IP
Legacy (novaNet)	If already available: BACnet/IP if not, novaNet Server on Sauter Vision Center
Fieldbus (I)	modu6**-CM modules for: DALI KNX-TP SMI Mbus
Fieldbus (II)	modu6**-CM modules or controller modu680-AS for: Modbus RTU BACnet/MSTP
SLC	with modu6**-AS
Industrial	OPC-UA on Sauter Vision Center
IoT, Cloud	modu612-LC RESTful API on modu6**-AS SMTP, SMPP on modu6**-AS Sauter Vision Center-API Cloud Connector
Network services	NTP

Table 7 Overview of modulo 6 integration solutions for different technologies.

As a BACnet system, SAUTER modulo 6 is, in principle, open for direct integration with all third-party BACnet systems or third-party systems that have the option of connecting to BACnet (e.g. gateways).

Furthermore, SAUTER EY-modulo 5 offers various integration options for incompatible BACnet third-party systems and the other SAUTER EY systems.

6.2 modulo 5

modu 5 and ecos 5 product lines are both native BACnet/IP solutions. They can be seamlessly integrated with modulo 6.

6.3 Legacy (novaNet)

novaNet based installations can be integrated following different strategies:

- Using further legacy products that support BACnet/IP
 - EY-AM300, EYK300
- Using further legacy products that can communicate with a PC running SAUTER Vision Center
 - EY-BU291, EY-BU292
 - novaNet Server

6.4 Fieldbus, SLC

Modulo 6 Building Controllers support the SLC protocol both on-board and with Fieldbus modules. Modbus RTU and BACnet/MSTP are also supported by modulo 6 stations both on-board and with Fieldbus modules. Other Fieldbus protocols are supported with dedicated Fieldbus modules. See the chapter on modulo 6 Communication Modules for details.

6.5 Industrial

SAUTER Vision Center allows the integration of third-party systems with the OPC UA industrial protocol.

6.6 IoT and the Cloud

modulo 6 provides a RESTful API for integration of Cloud Solutions. As soon as the standard is released, BACnet/SC (Secure Connect) will also be supported.

modulo 6 Automation Stations use MQTT as the protocol to link the **modu612-LC**. As they are also MQTT brokers, they can integrate 3rd party devices like sensors using this same protocol.

The ecos504-IoT (EY-RC504F202) also supports MQTT for IoT and cloud integration.

6.7 Network services

modulo 6 supports different IP Network-related services.

Meteomodul	This service is supplied by Sauter and provides a 3-day weather forecast for a given location to the Automation Station.
Hail warning	This service, available only in Switzerland, provides up-to-date information on the risk of hail at a given location to protect assets.
e-mail client SMTP	moduWeb Unity supports the configuration of an email client to send alarm notifications to registered users.
SMS via gateway	moduWeb Unity supports the configuration of an email-to-SMS gateway to send alarm notifications to registered users.
SMPP	moduWeb Unity supports the configuration of an SMS client to send alarm notifications to registered users.

Table 8 Network services that can be optionally supported by some modulo 6 stations.

Integrated CASE Suite service

7 Integrated CASE Suite service

CASE Suite is the integrated service package from SAUTER. The **software bundle** contains all necessary programs and libraries for the different service steps within a project – from **planning** and **engineering** to **commissioning** and **maintenance**.

The 1st main benefit of the program package is that all **data** entered is used homogeneously during the entire project processing and thus only needs to be **entered once**. “Data entered once” such as one’s own and third-party materials, services, data points, equipment and the functions thereof are available to all CASE programs for further processing. **This saves time, improves quality, reduces costs and helps to avoid errors.**

The 2nd main benefit is the extremely comprehensive **libraries with standard and sample solutions**. They allow **increased rationalisation** when it comes to **service work**. In just a few steps, solutions can be put together from the libraries following the customer’s requirements and can be individually adjusted if required. This compilation of systems out of “jigsaw” pieces is simple and optimises the engineering process. In addition to the excellent **solution quality**, years of accumulated **system know-how by SAUTER specialists** to be found in these libraries is used to great effect. All the same, customer-specific individual solutions are possible at every project management stage.

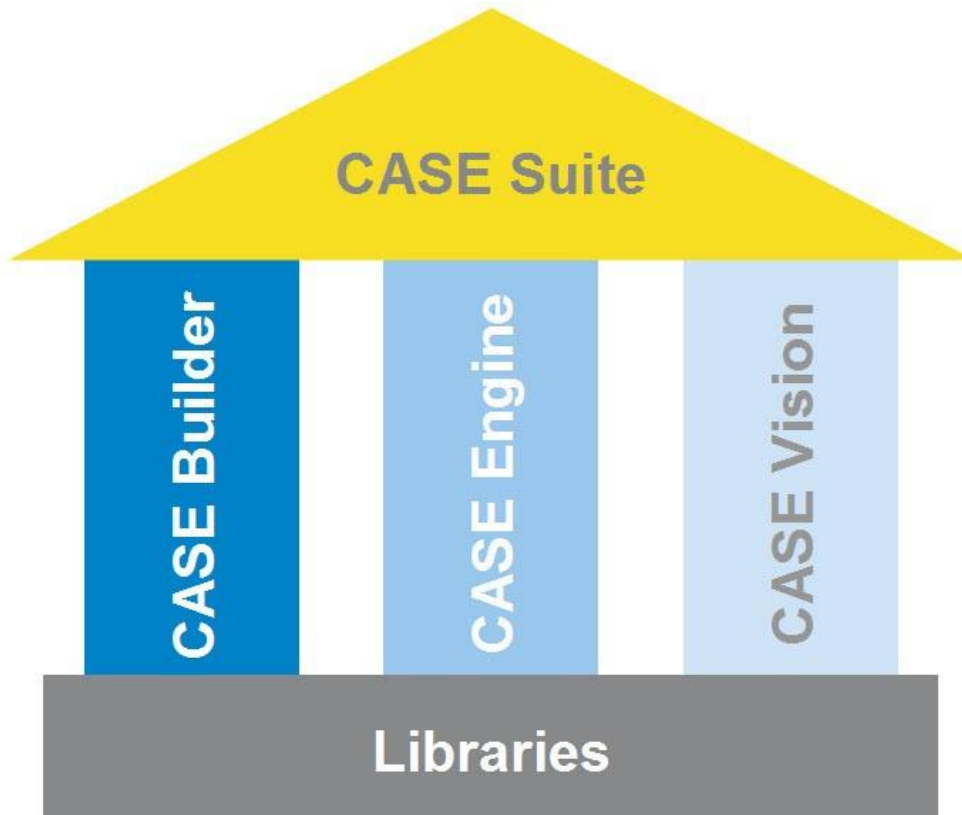

The **CASE Suite** platform comprises the following programs:

7.1 CASE Builder

The CASE Builder program has been designed for rational use in **technical project handling**. Pursuing the principle of automatically re-using values recorded once (e.g. data points, plant devices and their functions) during the course of the project without having to re-enter them in the individual project sections, a graphics program and Microsoft Office were used as a basis for developing a tool to meet this target.

With its **comprehensive library**, CASE Builder very efficiently generates all the necessary documents for design and implementation and adapts them to the specific requirements of the project. When putting together an installation (graphically or in a tree structure) from the existing function groups, all the necessary information is compiled so that the following items can be created at the touch of a button:

- Function descriptions
- Device, cable, motor and valve lists
- Data point lists, labels for automation stations

The project data thus obtained is saved in a project database and can be used for subsequent project management and documentation. The process plans and data point information created by CASE Builder can be used by the SAUTER applications for system visualisation.

7.2 CASE Engine

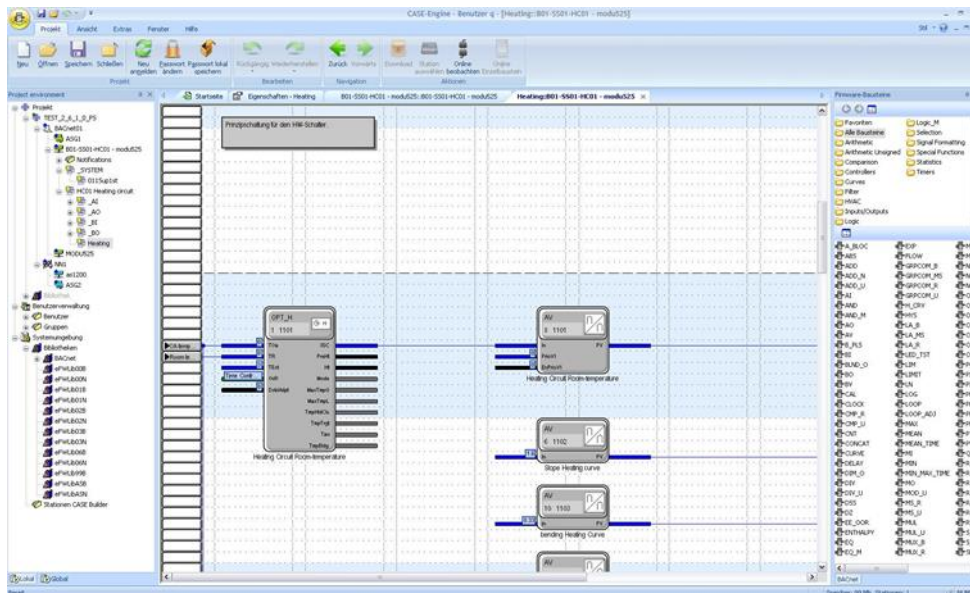

The CASE Engine editor and **integrated library** enable you to quickly create the graphics for the **system-specific automation station software** as part of a project. This allows the **function plans** to be created and the stations parameterised. Control procedures are **graphically** represented and therefore easier to monitor.

The programming is based on the **IEC 61131-3 (FBD) standard**, which makes using CASE Engine even easier. As well as this, CASE Engine allows you to work in a team.

Integrated CASE Suite service

With access to a **shared project database**, the same information is available to all team members at the same time (simultaneous engineering).

7.3 CASE Vision

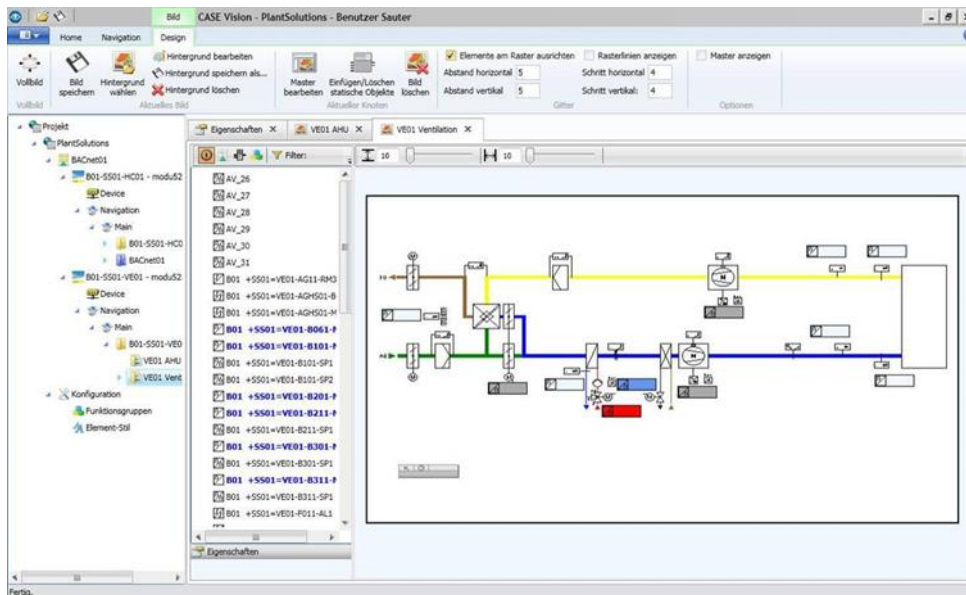

The CASE Vision program is designed for the simple creation of **system navigation trees** and **dynamic** system diagrams for various visualisation applications from SAUTER.

The project data from CASE Engine is used as data point references. The images and navigation structures are prepared using CASE Vision and subsequently displayed in the visualisation applications or refined as necessary.

7.4 CASE Library Management

The **CASE Library Browser** program is designed for displaying the installed library packages and components, and also for deleting them when necessary.

The **CASE Library Manager** program allows administrators to create and manage library packages so that they can be passed on to users.

CASE Library Import can be used for integrating additional library packages in the CASE package. This means they are subsequently available to users when creating the project.

7.5 Components

7.5.1 CASE VAV

All the necessary settings for trouble-free operation of the ASV 115 and ASV 2*5 can be made in the menus of the CASE VAV software tool. Additionally, the most important parameters for the input and output configuration are preset to enable efficient commissioning. Special functions for network configuration, network switching between

SLC and BACnet MS/TP, online monitoring and troubleshooting complete the scope of functions. An integrated BACnet browser enables the configuration of the ASV in BACnet MS/TP mode.

7.5.2 CASE VAV Factory

A user interface for downloading, with predefined parameterisation using CASE VAV, for the ASV 115 and ASV 2*5 VAV compact controllers. Ideal for OEM customers and for operation by users with little or no experience in VAV applications. The application offers the following advantages:

- The settings for ASV 115 and ASV 2*5 can be made with a few mouse clicks and without entering parameters.
- Optimised throughput time when pre-setting the ASV 115 and ASV 2*5 at VAV box manufacturers
- Documentation of downloads in a log

7.5.3 CASE TPC (Touch Panel Configurator)

The CASE TPC software is designed for programming the EYT250 graphically. The software not only makes it easy to create the function interface but also to configure and commission the EYT250 and to modify structures and parameters.

7.5.4 CASE Drives

CASE Drives is a program for commissioning the SAUTER ASM105SF132 and ASM115SF132 damper actuators and the AVM105SF132 and AVM115SF132 valve actuators. CASE Drives allows you to set and read the actuator parameters on site. Connection is made using a serial interface on the PC.

7.5.5 CASE Sensors

CASE Sensors allows you to configure and monitor SAUTER sensors. All parameters that can be modified using hardware operating elements can be set using this application. It also makes other parameters available for setting, depending on the device. CASE Sensors supports the following sensors: SGUF010/011 sash sensor and EGP and SDX differential pressure sensors.

7.6 CASE Tools

The CASE tools offer various useful functions, including:

7.6.1 CASE Export

CASE Export allows information from the automation stations such as parameters of I/O modules (house address, address text, dimensions etc.) to be made available to other applications.

Integrated CASE Suite service

7.6.2 CASE Export BACnet

The CASE Export BACnet program creates EDE (Engineering Data Exchange) files (Format 2) for BACnet stations (SAUTER EY-modulo 3, EY-modulo 5 and modulo 6) and makes them available to other applications.

7.6.3 CASE Export novaNet

CASE Export novaNet provides three functions: Exporting BMT parameters without groups (BMT 5.1), exporting BMT parameters with all tables (BMT 5.1 All Tables) and exporting the EDE file.

7.6.4 CASE Import

During modernisation projects or if an old Automation Station fails, stations from the EY2400 system are often replaced with state-of-the-art stations from the EY-modulo 5 system.

This is where CASE Import is used. The address designations of the EY2400 station do not have to be typed in again, but can be transferred from the EY2400- FuPlan project to a current EY-modulo 5 project with CASE Builder. As well as this, a terminal list with the old and new terminal numbers is created so that the existing equipment can be very easily connected to the EY-modulo 5 station.

7.6.5 BACnet Server Configurator

The IP address and other parameters of the novaNet-BACnet application master (EY-modulo 5: EY-AM 300) are configured using the SAUTER BACnet Server Configurator software module.

The configuration is transferred via the serial COM port (DB9 connector) or the Ethernet / IP port and saved in a flash memory where it is protected from power failure. Data transfer via IP takes place using the fixed TCP port 51966.

7.7 Communication

7.7.1 CASE HWC (hardware commissioning)

The hardware commissioning program is used to efficiently check the automation stations (novaNet AS) of the system and the connected field devices. After the hardware is commissioned, the program can be used for troubleshooting any initial errors.

7.7.2 CASE Sun

CASE Sun is the configuration tool for the Automation Stations and ecos stations in the SAUTER EY-modulo 5 range. CASE Sun enables you to perform the Ethernet network configuration, the 1:1 test during commissioning and the update of the firmware on the stations if necessary. CASE Sun is designed both for SAUTER service engineers and for electricians on site.

The CASE TCM (CASE Touch Configuration Manager) application can be called up directly from CASE Sun. CASE TCM is used for configuring the touchscreen operating devices for moduWeb Vision.

The SAUTER Licence Manager application can be used to license devices detected by CASE Sun.

novaNet292 Configurator

The novaNet292 Configurator is for configuring the novaNet292 Ethernet access device, setting the IP address of the port number etc.

novaVPort

novaVPort starts the communication driver for virtual COM ports. After selecting the configured driver to be started, you can use the novaNet292 VirtualPort Monitor to view the status and various information (such as version information) regarding novaNet292. If no application is using the port, users can stop the novaVPort driver.

7.7.3 novaMit29x

novaMit29x is an analysis tool for the novaNet communication protocol. It can record data transfer from the network and then analyse it.

7.7.4 Virtual Port Configurator

The Virtual Port Configurator visualises the settings of the virtual COM-Port drivers and allows you to change them. The following ways to configure the virtual ports are supported:

- *Communication with the moduNet292 device (novaVPort driver)*
- *Communication between CASE VAV and the ASV actuators on the SLC bus connected to an ecos station*
- *Communication between the SMI commissioning tool (Easy Monitor) and the devices on the SMI bus of an ecos communication module*

Further information**8 Further information**

The following topics are briefly summarised here:

- BACnet communication protocol. The backbone of building automation.

8.1 BACnet Communication Protocol**8.1.1 BACnet**

The BACnet used by the SAUTER modulo automation and room Automation Stations is an open data communication protocol for building automation (Building Automation and Control network). This manufacturer-neutral communication standard defines and describes a “shared language” that supports data communication between different systems (heating, ventilation, fire alarm and security) and, particularly, between devices from different manufacturers. The aim is to keep installations open in the event of expansions, replacements etc.

The BACnet standard is a development from ASHRAE (ASHRAE, 2016) (American Society of Heating, Refrigerating and Air-Conditioning Engineers). It was established in 1987. In 1995, BACnet became an ASHRAE/ANSI standard and, in 2003, an international standard (ISO 16484-5) and a European standard (EN ISO 16484-5). The BACnet standard is developed continuously in different working groups.

For the mapping of the various elements of the BAS, the BACnet standard defines standardised objects for the different data point types and for specific functions. Inputs, outputs and setpoints have standardised objects for all of the supported data types, e.g. analogue input object, binary output object and multi-state value object. Standardised objects are also defined for schedules, calendars, PID control loops, protocols etc. Each object has a set of properties, some of which are obligatory for the individual objects to define them uniquely (Object_Identifier, Object_Type, Object_Name and Property_List).

The standard also defines BACnet services for access to objects or for the execution of functions. A total of 38 services are available (e.g. reading and writing object properties or executing functions on other devices, such as restart, login for alarms etc.). In addition to reading properties (e.g. the current value), there is also, in particular, a service for subscribing to a value. The value (the property) is then automatically reported by the original object to the subscriber as soon as it changes (COV notification).

Example of analogue input:

Object_Name	SPACE TEMPERATURE
Object_Type	ANALOG INPUT
Present_Value	22.3
Status_Flags	OUT-OF-SERVICE
High_Limit	24
Low_Limit	20

Table 9 Some properties of an analogue input BACnet object.

In addition to the standard objects, properties and services, the standard allows optional definition and use of proprietary objects, features and services.

The BACnet standard supports different communication platforms, e.g. PTP (point to point) - EIA-232, MS/TP (Master-Slave/Token Passing) - EIA-485, Ethernet - ISO 8802-3 (Ethernet direct, without IP), LonTalk and, of course, BACnet/IP as used by SAUTER modulo stations.

8.1.2 Native BACnet

Native BACnet devices are devices that are structured homogeneously following the BACnet standard and that therefore require no conversion (gateway, conversation processor etc.) for BACnet communication. The inputs and outputs are mapped directly in the device as BACnet objects.

All SAUTER modulo stations use native BACnet technology. Not only the inputs and outputs are mapped as BACnet objects, but also most of the other objects such as control loops, Calendar objects and Trend objects.

8.1.3 BACnet/IP

BACnet/IP uses the widespread IP protocol for communication between the BACnet devices (automation devices, PCs, etc.). Each BACnet device is IP-ready and has its IP address (i.e. it is an IP node).

This allows the building automation system to be integrated into Enterprise IP networks or the Internet, and the devices can communicate with one another across the network. (See section on Topologies / access / security).

A BACnet/IP network is a virtual network that stretches across one or more IP subnetworks (IP domains) and has a single BACnet network number. This virtual BACnet/IP network contains BACnet/IP nodes that communicate with one another employing the BACnet/IP protocol across different physical networks (subnets). A BACnet broadcast management device (BBMD) manages the IP broadcasts used by BACnet and forwards them in a targeted manner to the IP networks in question. This

Further information

allows communication via several physical IP networks without placing unnecessary strain on the overall network.

Topologies / access / security

BACnet/IP can, in principle, be operated in every IP network. (Even the moduWeb Unity functions of the AS (operation with browser, e-mail) generally fit easily into every IP LAN / WAN / Internet environment.)

Due to the open design of BACnet/IP, SAUTER urgently recommends preventing all BACnet/IP traffic with the Internet and all external access from the Internet to the BACnet/IP network. SAUTER recommends following the recommendations of the IEC 62443 standard. Customers should evaluate the dangers and the risks of their solution and formulate the requirements accordingly.

One of the recommendations is to properly split the network into zones with strong restrictions for communication between zones. For example, it is common to split the office LAN (IT, Enterprise Network) from the operations LAN (OT, Production LAN, Building Automation LAN). Within the BA Network, only Building Automation devices are connected and while this condition is respected, the use of BACnet/IP does not represent a threat. To provide access to operational information from outside the network, either Sauter Vision Center or the embedded web servers moduWeb, moduWeb Vision or moduWeb Unity provide secure access and encrypted communication.

Depending on the project's risk evaluation and cost, the BA may be directly integrated into the customer's IT infrastructure. During integration into an existing customer IP network, it is generally recommended that the BMS components be logically separated from the office LAN by bundling the building controllers and the BMS operating stations into a VLAN (virtual LAN).

Except for very small systems, the bypassing of NAT router(s) and/or firewall(s) requires either a BACnet router or a VPN needs to be set up for access. Access via VPN is also a very advisable solution. On the one hand, this is due to the clear delineation and thus increased security and, on the other hand, due to the simpler configuration. Access via VPN means that the operating stations on the Internet are integrated virtually into the LAN/VLAN of the stations using appropriate VPN client drivers.

In any event, to allow external access, appropriate measures and configurations must be performed for the Internet access and firewall.

For this reason, discussion and collaboration with the customer's IT managers – even during the planning phase – is indispensable for the implementation in the customer's IT environment.

8.1.4 BACnet/MSTP

BACnet/MSTP uses the widespread RS-485 as the physical layer (see Figure 5). In contrast to IP, the reduced bandwidth and linear topology present significant restrictions

that limit the reactivity of the BACnet communication. Important latency times compared to BACnet/IP must be taken into account.

The operating principle of BACnet/MSTP is firstly based on differentiating between master and slave participants, whereby master devices exclusively send requests and slave devices can exclusively respond. Secondly, the token is passed from device to device and only the device with the token can send requests. There is no need to have the token to send answers. This operating mode supports basic BACnet functions such as device restoring. However, the limitations of RS-485 and MSTP mean that BACnet/MSTP is not designed for LAN operation. Instead, it is well suited for short branches with a limited number of devices like sensors and actuators.

8.1.5 BACnet/SC

The digital revolution has brought many benefits but also some additional risks. Cybersecurity is a critical topic when strategic assets and facilities are at stake. With BACnet Secure Connect, the BACnet protocol is encrypted and can be easily integrated into the IT topology and the Internet.

Based on WebSockets and TLS, this evolution of the BACnet protocol provides BACnet with standardised security mechanisms for encryption to secure data confidentiality.

BACnet/SC is described in Annex AB of the BACnet Standard and includes important changes to BACnet/IP (see Figure 6). The use of TLS is not an option but is intrinsic to Secure Connect. Thus, certificate management is one of the requirements that must be fulfilled when setting up a BACnet/SC network. Further, TCP is used instead of UDP. Another important aspect is that communication is centralised in a hub, following a hub and spoke model. Nevertheless, node-to-node communication is still possible.

Figure 3 represents a topology combining BACnet/SC and BACnet/IP networks. A routing device must be used between the two networks. For security reasons, the routing is not completely transparent, as it would make no sense that an unsecured device in the BACnet/IP network would be allowed to send commands to the BACnet/SC network.

An additional benefit of BACnet/SC is that it can work in IPv4 and IPv6 networks. Figure 6 represents the construction of BACnet/SC following the OSI layer model.

Further information

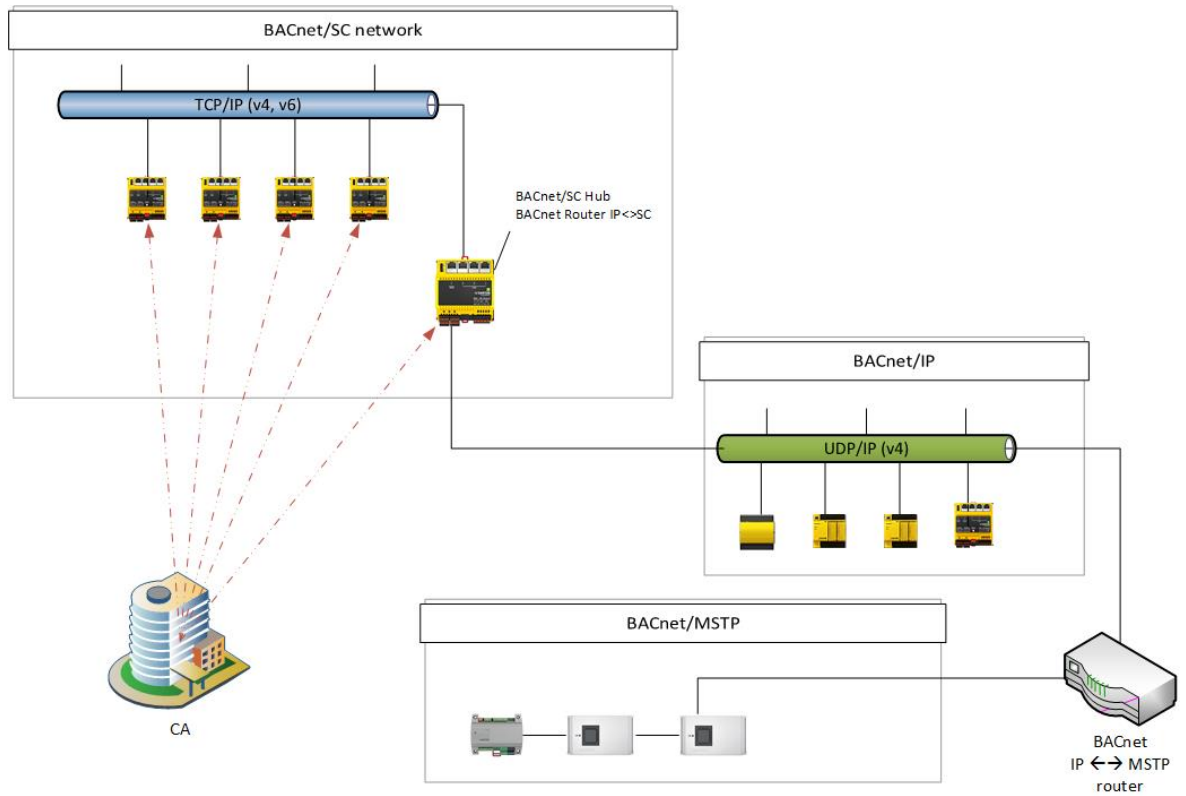

Figure 3 Various BACnet networks and devices

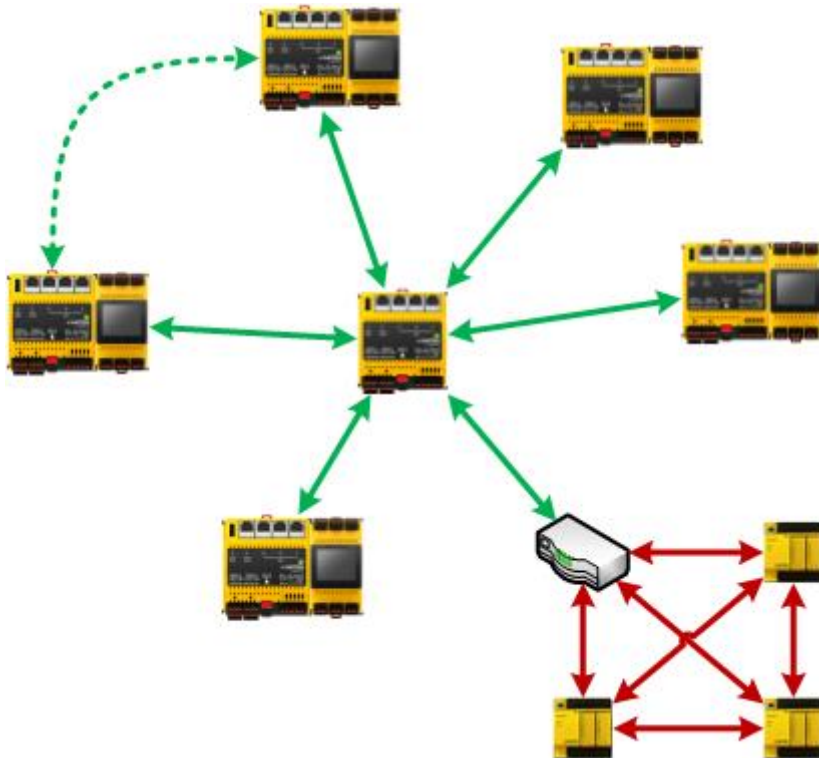

Figure 4 Hub and spoke topology of BACnet/SC. While the BACnet/SC communication is centralised in the hub, the BACnet/IP communication is station-to-station or broadcast.

Further information

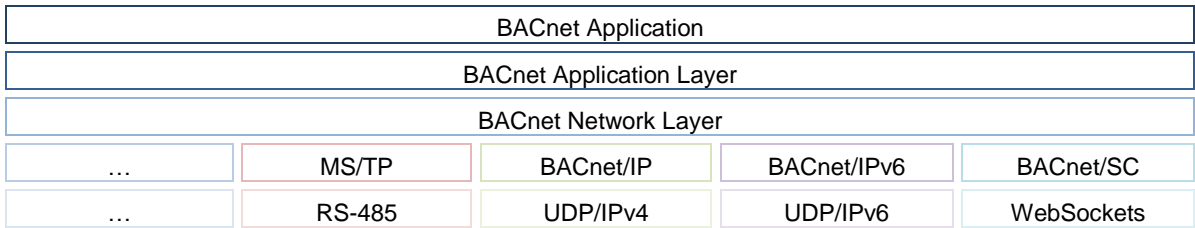

Figure 5 Representation of the different BACnet layers in the OSI layer model

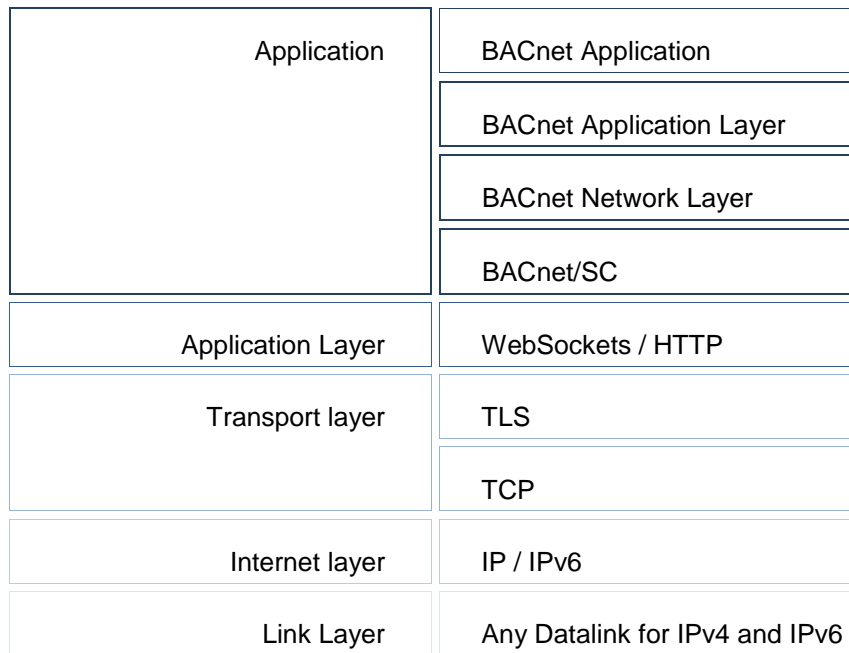

Figure 6 Representation of the BACnet/SC layers and the OSI layer model.

8.2 MQTT Communication Protocol

Message Queue Telemetry Transport (MQTT) is an open protocol (ISO/IEC 20922:2016) for machine-to-machine (M2M) communication that enables the transmission of telemetry data despite delays or limited networks. The protocol was first released in 1999 by IBM® and Cirrus Link.

The ease of use and widespread use of the MQTT protocol makes it one of the most widely used technologies for IoT and the Cloud. Various web links explain the differences between the various IoT protocols (AMQP, CoAP, XMPP, DDS, OPC UA, WAMP, etc.). Since 2010, MQTT has been available under a free licence, so many open-source implementations are possible.

The most important features of MQTT:

- Lightweight protocol with low transport overheads
- MQTT is suitable for:

Further information

- The exchange of messages between devices with low functionality
- Transmission via unreliable networks with low bandwidth and high latency time
- The Publish/Subscribe messages of an MQTT client as a one-to-many message for an MQTT broker are kept in the Topics so that decoupling from the applications is possible. An MQTT client can be an MQTT publisher or subscriber, or both. An MQTT broker (often and more recently also called an MQTT server) forwards the current information via Topic Name to the respective MQTT subscribers.
- The telegram content MQTT payload can be freely designed (information usually in XML or JSON format) and is available as a topic on the MQTT broker.
- Three reliability levels QoS levels (Quality of Service) provide quality assurance for message delivery.
- Encryption of the messages with SSL/TLS and authentication of the Publishers/Subscribers via user and password.
- The simple communication protocol uses TCP/IP without encryption via port 1883 (MQTT) or with encryption via TLS via port 8883 (secure-MQTT).
- Easy usage and implementation and a limited quantity of commands (Control Packet).
- And more:
 - Minimal need for network bandwidth due to the push mechanism
 - Function for setting up a connection again after it is interrupted
 - Resending messages after a connection interruption
 - Mechanism to notify interested parties after unforeseen connection interruption for a client

Further useful links:

Wikipedia: <https://de.wikipedia.org/wiki/MQTT>
 Blog: <https://blog.doubleslash.de/mqtt-fuer-dummies>
 HiveMQ: <https://www.hivemq.com/blog/mqtt-essentials>
 Mosquitto: <https://projects.eclipse.org/projects/technology.mosquitto>

Further useful sources:

ISO/IEC 20922:2016: <https://www.iso.org/standard/69466.html>

MQTTOrganisation: <http://mqtt.org/>

OASIS Organisation: https://www.oasis-open.org/committees/tc_home.php?wg_abbrev=mqtt

Since MQTT is a public, licence-free standard, there are many community platforms in addition to commercial Cloud platforms (Amazon AWS, IBM Cloud/Bluemix, Google Cloud, Microsoft Azure, etc).

MQTT functionality is an option that can be activated with the following licenses:

Function	License
MQTT Client	Y6FX002F001
MQTT Broker&Client	Y6FX002F002

Further information

8.3 8.3 IEC 62443

The development of modulo 6, especially concerning the Security by Design strategy, is based on the IEC 62443 standard, which is aimed at "Industrial Communication Networks - Network and System Security".

The standard defines requirements for the systems, which are divided into seven categories (FR: Fundamental Requirements):

- IAC: Identification and Authentication Control
- UC: Use Control
- SI: System Integrity
- DC: Data Confidentiality
- RDF: Restricted Data Flow
- TRE: Timely Response to Events
- RA: Resource Availability

The standard also defines so-called security levels:

- SL 1: Protection against casual or accidental injury
- SL 2: Protection against intentional injury by simple means with few resources, general skills and low motivation
- SL 3: Protection against intentional injury using sophisticated means with moderate resources, IACS-specific skills and motivation
- SL 4: Protection against intentional injury by sophisticated means with enhanced resources, IACS-specific capabilities and high motivation

For each security level, the corresponding minimum requirements from each category have been defined in the standard. The higher the Security Level that you want to achieve on a system, the higher the requirements and the costs. The requirements are directed at the complete solution so that no possible deviations of a certain component are considered, but the complete solution. If required, the system can be segmented into zones with different SL levels.

More details can be found in document D100389344 "modulo 6 compliance statement to IEC 62443 Requirements".

8.4 Port-based Network Access Control, IEEE 802.1X

The purpose of this functionality is to increase network security by requiring the authentication of devices wishing to connect to a (W)LAN. This standard defines the authentication mechanisms required to authorise the access of a device to a network. EAPOL and RADIUS are protocols which are used for this purpose.

This solution involves typically three parties: A supplicant, which is the device that wants to use the network, an authenticator which controls the access to the network and an authentication server, which verifies if the credentials of the supplicant are authorised.

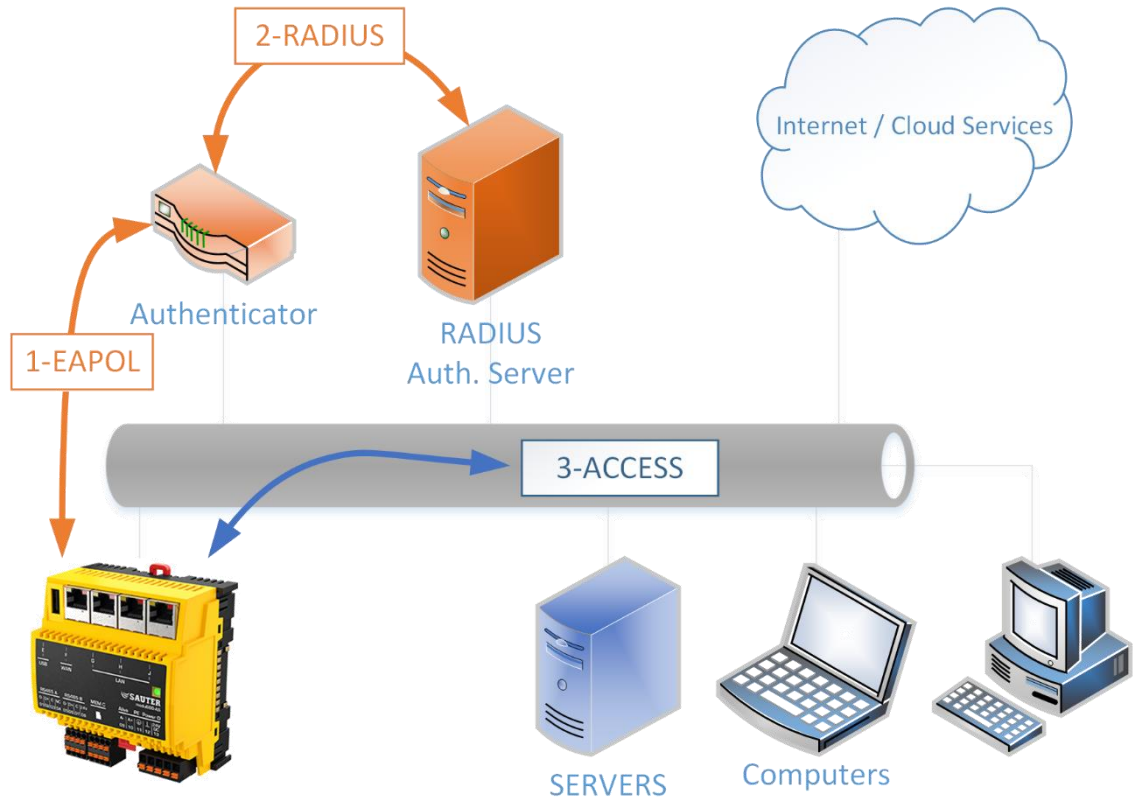

Figure 7 802.1X topology and protocols
 1. Authorization Request
 2. Identity check
 3. Access to ressources

Supplicant	Authenticator	Authentication Server
<ul style="list-style-type: none"> Automation Station 	<ul style="list-style-type: none"> Managed Network Switch Wireless Access Point 	<ul style="list-style-type: none"> RADIUS Server

The credentials and certificates needed to set up this solution must be provided by the network owner.

This function is optional and can be enabled with the following licenses

Device	Function	License
modu680-AS, modu660-AS	Supplicant	Y6FX03F001
ecos504, ecos505	Supplicant	YY-FX03F001

Contents

Glossary

A

- AI
 Analog Input 35, 39
 BACnet Analog Input 17, 20
- AMQP
 Advanced Message Queuing Protocol..... 83
- ANSI
 American National Standards Institute.... 45, 77
- AO
 Analog Output..... 38, 39
 BACnet Analog Output 17, 20
- API
 Application Programming Interface.... 6, 17, 20,
 25, 50, 51, 66, 69, 70
- ASHRAE
 American Society of Heating, Refrigerating and
 Air-Conditioning Engineers..... 77
- AV
 BACnet Analog Value 17, 20

B

- B/IP
 BACnet over IPv4 29
- B/SC
 BACnet Secure Connect..... 29
- BACnet
 Building automation and control network 6, 8, 9,
 10, 11, 14, 17, 18, 20, 21, 23, 24, 26, 29,
 45, 51, 56, 57, 58, 59, 69, 70, 74, 75, 77,
 78, 79, 80, 81, 82, 83
- BAS
 Building Automation System 8, 9
- B-BC
 BACnet Building Controller 17
- BI
 BACnet Binary Input 17, 20
- BloT
 Building - Internet of Things..... 6, 9, 26
- BLND_O
 Sauter Blind Output (Proprietary)..... 17, 20
- BLND_O2
 Sauter Blind Output 2 (Proprietary)..... 17
- BLND_O2
 Sauter Blind Output 2 (Proprietary)..... 20
- BMS
 Building Management System 10, 49, 79
- BO

- BACnet Binary Output 17, 20
- BV
 BACnet Analog Value..... 17, 20

C

- CAL
 BACnet Calendar..... 17, 20
- CASE
 Computer Aided Sauter Engineering .. 8, 19, 21
- CI
 Counter Input..... 34, 35, 38, 39
- CoAP
 Constrained Application Protocol..... 83
- CSS3
 Cascading Style Sheets Level 3 49

D

- DALI
 Digital Addressable Lighting Interface ... 56, 57,
 58, 69
- DDS
 Data Distribution Service 83
- DEV
 BACnet Device 17, 20
- DI
 Digital Input 34, 35, 38, 39
- DIM_O
 Sauter Dimmable Output (Proprietary) ... 17, 20
- DIN
 Deutsches Institut für Normung 10
 Deutsches Institut für Normung e.V..... 58
- DO
 Digital Output..... 37, 39
- DP
 Data Point..... 43, 44, 46, 50

E

- EAPOL
 Extensible Authentication Protocol over LAN85
- EE
 BACnet Event Enrollment..... 17, 20
- EIA
 Electronic Industries Alliance..... 45, 78
- EL
 BACnet Event Log..... 17, 20

Glossary

F

ftp
File Transfer Protocol 49

G

GND
Earth 17

H

HTML5
Hypertext markup language..... 10
Hypertext Markup Language version 5..18, 21,
49, 65
https
Hypertext Transfer Protocol Secure..... 49, 84
HVAC
Heating Ventilation Air Conditioning ..6, 10, 19,
21

I

I/O
Input/Output6
IBM
International Business Machines Corporation
(R) 83
IEC
International Electrotechnical Commission6,
11, 53, 72, 79, 83, 84, 85
IEEE
Institute of Electrical and Electronics Engineers
..... 85
IoT
Internet of Things..... 9, 69, 70
IP
Internet Protocol 6, 8, 9, 11, 12, 17, 20, 23, 25,
26, 45, 49, 50, 51, 56, 69, 70, 75, 76, 78,
79, 80, 82, 83, 84
IRC
Integrated Room Control 10

J

JS
JavaScript..... 49

K

KNX-TP
KNX - Twisted Pair 69

L

LAN
Local area network 9
LED
Light Emitting Diode 18, 20, 25, 29, 34, 35, 36,
37, 38, 39, 40, 41, 44, 46, 54, 59, 60
LO
BACnet Lighting Output..... 17, 20
LOI
Local Operation and Indication 10
LOOP
BACnet loop 17, 20

M

M2M
Machine to Machine 83
Mbus
Meter-Bus..... 43, 46, 56, 57, 58, 69
MI
BACnet Multistate Input..... 17, 20
MO
BACnet Multistate Output 17, 20
MQTT
Message Queue Telemetry Transport9, 16, 17,
20, 25, 26, 54, 55, 57, 59, 70, 83, 84
MSTP
Master-Slave/Token Passing10, 17, 18, 20, 69,
70, 79, 80
MV
BACnet Multistate Value..... 17, 20

N

NC
BACnet Notification Class 17, 20
NTP
Network Time Protocol 69

O

OC
Open collector 37
OPC DA

Further information

Open Platform Communication - Data Acquisition.....	66
OPC UA	
Open Platform Communication Unified Architecture	83
OPT_C	
Sauter Cooling Optimization (Proprietary) ...	17, 20
OPT_H	
Sauter Heating Optimization (Proprietary) ...	17, 20

P

PC	
BACnet Pulse Counter.....	17, 20
PIV	
BACnet Positive Integer Value	17, 20
PNAC	
Port-based Network Access Control	16
PRG	
BACnet Program.....	17, 20

Q

QoS	
Quality of Service.....	84

R

RADIUS	
Remote Authentication dial-In User Service .	85
RESTful	
REpresentational State Transfer-ful...6, 17, 20, 25, 50, 69, 70	
RTC	
Real Time Clock	14, 23, 24
RTU	
Remote Terminal Unit10, 18, 43, 44, 45, 69, 70	

S

SCHED	
BACnet Scheduler	17, 20
SLC	
SAUTER Local Communication. 10, 14, 15, 17, 18, 19, 20, 21, 22, 56, 60, 62, 69, 70, 74, 76	
SD card	

Single Layer Cell	17, 20, 25
SMI	
Standard Motor Interface	46, 56, 57, 58, 69, 76
SMPP	
Short Message Peer-to-Peer	17, 20, 54, 69, 70
SMTP	
Simple Messaging Text Protocol	17, 20, 54, 69, 70
SNMP	
Simple Network Management Protocol	69
SSL	
Secure sockets layer	84
SVC	
SAUTER Vision Center	6, 66, 67

T

TCP	
Transmission Control Protocol	80
TIA	
Telecommunications Industry Association....	45
TL	
BACnet Trend Log.....	17, 20
TLS	
Transport Layer Security	29, 80, 84

U

UI	
Universal Input.....	35, 39, 57
UL	
Unit Load	43, 44, 46, 47
USB	
Universal Serial Bus	14, 17, 20, 25

W

WAMP	
Web Application Messaging Protocol	83
WAN	
Wide Area Network.....	10

X

XMPP	
Extensible Messaging and Presence Protocol	83

List of Figures

List of Figures

Figure 1	modulo 6 connectivity.....	9
Figure 2	Graphical user interface	41
Figure 3	Various BACnet networks and devices	81
Figure 4	Hub and spoke topology of BACnet/SC. While the BACnet/SC communication is centralised in the hub, the BACnet/IP communication is station-to-station or broadcast.....	82
Figure 5	Representation of the different BACnet layers in the OSI layer model	83
Figure 6	Representation of the BACnet/SC layers and the OSI layer model	83
Figure 7	802.1X topology and protocols 1. Authorization Request 2. Identity check 3. Access to ressources	86

List of tables

Table 1	Compilation of signals available on each I/O module.	33
Table 2	Examples of maximum load by type of plant.....	47
Table 3	The table shows which is the standard, default variant on each device, and which upgrades are possible.....	49
Table 4	References for upgrading the web server	50
Table 5	Available references and related interfaces. • 1 Interface, •• 2 Interfaces.	57
Table 6	Functions additionally activated in EY-RC504	57
Table 7	Overview of modulo 6 integration solutions for different technologies.....	69
Table 8	Network services that can be optionally supported by some modulo 6 stations.	70
Table 9	Some properties of an analogue input BACnet object.	78

© Fr. Sauter AG
Im Surinam 55
CH-4058 Basle
Tel. +41 61 - 695 55 55
Fax +41 61 - 695 55 10
www.sauter-controls.com
info@sauter-controls.com
Subject to change without
notice

Printed in
Switzerland